

MAZDA

GB	PROTECTION FOIL Installation Instruction
D	SCHUTZFOLIE Einbauanleitung
E	LAMINA DE PROTECCIÓN Instrucciones de montaje
F	PELLICULE DE PROTECTION Instructions de montage
I	FOGLIO DI PROTEZIONE Istruzioni di montaggio
P	FOHLA DE PROTECCIÓN Instruções de montagem
NL	BESCHERMFOLIE Inbouw-instructie
DK	BESKYTTELSFOLIE Monteringsvejledning

N	BESKYTTELSFOLIE Monteringsveiledning
S	SKYDDSFOLIE Monteringsanvisning
SF	SUOJAKALVO Asennusohje
CZ	OCHRANNÁ FÓLIE Návod k montáži
H	CSOMMAGTÉRÉL-VÉDÁFÓLIA Beszerelési utasítás
PL	FOLIA OCHRONNA Instrukcja zabudowy
GR	ΠΡΟΣΤΑΤΕΥΤΙΚΟ Οδηγίες τοποθέτησης
RUS	ЗАЩИТНЫЙ инструкция по установке

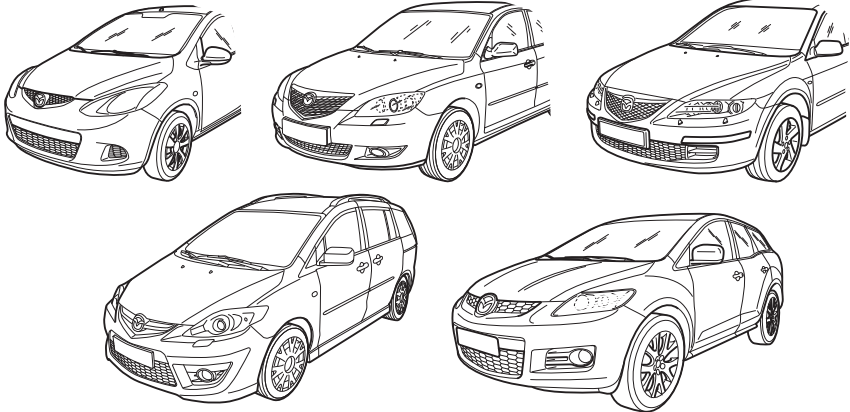

Part Number: DF71-V4-085
BK4K-V4-085
CC29-V4-085
GR6A-V4-085
EH14-V4-085

Date: 27-02-2009

© Copyright MAZDA

Sheet 1 of 24

Expert Fitment Required
Montage durch Fachwerkstatt erforderlich
Montaje sólo por el concesionario
Montage par spécialiste nécessaire
E' necessario in officina specializzata
Especialista em montage requerido
Montage door vakman nodig
Montage ved professionelt værksted påkrævet
Nødvendig med montering fra fagvejværksted
Værkstedsmontage erfordras
Asennus tarpeen merkikorjaamossa
Montáž ve specializované dílně nutná
A szereléshez szakműhely kell
Niecoznaczny montaż przez warsztat specjalistyczny
Να τοποθετη από συνεργείο
Необходима установка специалистами



- (GB)** Movement Arrow
- (D)** Bewegungspfeil
- (E)** Flecha de movimiento
- (F)** Flèche indiquant sens du mouvement
- (I)** Freccia di movimento
- (P)** Flexa de movimento
- (NL)** Richtingspijl
- (DK)** Bevægelsespil
- (N)** Bevægelsespil
- (S)** Rörelsepil
- (SF)** Liikesuuntanuoli
- (CZ)** Šípka pohybu
- (H)** Mozgásirányjelző nyíl
- (PL)** Strzałka kierunku ruchu
- (GR)** Βέλος κίνησης
- (RUS)** Стрелка по направлению



- (GB)** 2 Man Operation Required
- (D)** Nur zu zweit ausführen
- (E)** Realizar sólo entre dos personas
- (F)** Toujours s'y mettre de deux
- (I)** Da eseguire soltanto in due
- (P)** Executar somente a dois
- (NL)** Met 2 personen uitvoeren
- (DK)** Skal udføres af to personer
- (N)** Må utføres av to personer
- (S)** Utförs endast av två personer
- (SF)** Tehtävä kahdestaan
- (CZ)** Provádūt jen ve dvou
- (H)** Csak két személy végezheti el
- (PL)** Wykonywać tylko w dwie osoby
- (GR)** Να εκτελεσθεί από δύο άτομα
- (RUS)** Выполняйте вдвоём



- (GB)** Throw away
- (D)** Entsorgen
- (E)** Tirar a la basura
- (F)** Jeter aux déchets
- (I)** Smaltire
- (P)** Eliminar
- (NL)** Weggooien
- (DK)** Affald
- (N)** Avskaffe
- (S)** Ta hand om avfallet
- (SF)** Hävittää
- (CZ)** Vyhodit
- (H)** Távolítsa el
- (PL)** Usunąć jako odpad
- (GR)** Απόσυρση
- (RUS)** Выбросите



- (GB)** Use Hair Dryer
- (D)** Haartrockner verwenden
- (E)** Utilizar secador de aire caliente
- (F)** Utiliser un sèche-cheveux
- (I)** Utilizzare asciugacapelli
- (P)** Utilizar secador
- (NL)** Fohn
- (DK)** Hårtorrer anvendes
- (N)** Bruk hårtørker
- (S)** Använd fön
- (SF)** Käytä hiustenkuivaajaa
- (CZ)** Použít vysoušeč vlasů
- (H)** Használjon hajszárítót
- (PL)** Stosować suszarkę do włosów
- (GR)** Χρησιμοποιείτε σεσουάρ
- (RUS)** Используйте фен

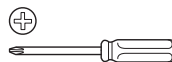

- (GB)** Phillips Screwdriver
- (D)** Kreuzschraubendreher
- (E)** Destornillador de estrella
- (F)** Tournevis cruciforme
- (I)** Cacciavite a croce
- (P)** Utilizar chave de fendas cruzada
- (NL)** Kruiskopschroevendraaier
- (DK)** Krydskærvskruetrækker anvendes
- (N)** Bruk stjemeskrujern
- (S)** Använd skruvmejsel för krysspår
- (SF)** Käytä ristipääruuvitaltaa
- (CZ)** Použít křížový šroubovák
- (H)** Használjon keresztféjú csavarhűzőt
- (PL)** Stosować Śrubokręt krzyżowy
- (GR)** Χρησιμοποιείτε κατασβίδ για βίδες φιλίπς
- (RUS)** Используйте крестовую отвёртку

MAZDA 2 DE

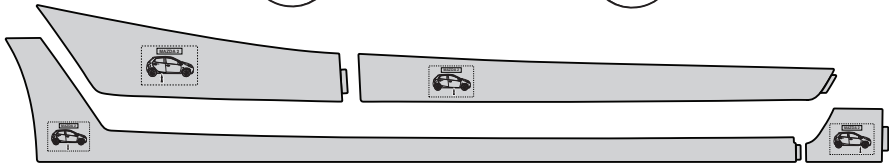
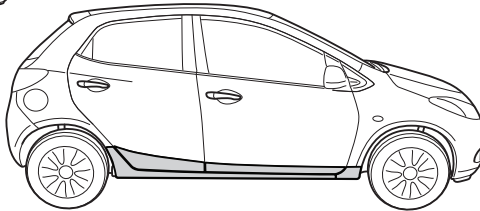
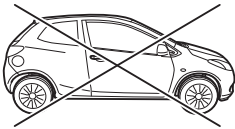
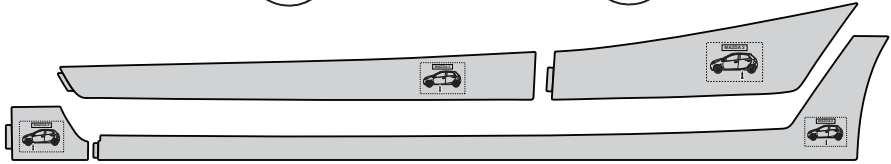
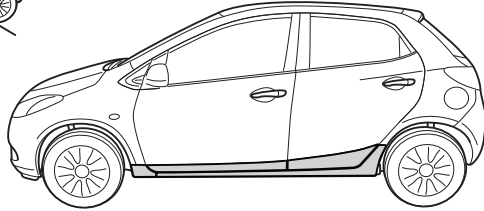
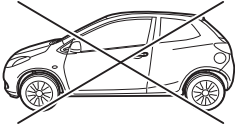

MAZDA 3 BK

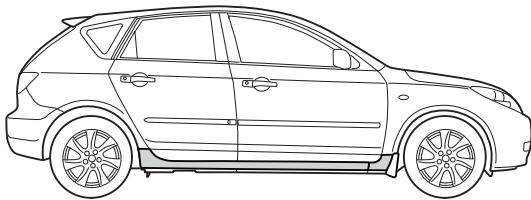
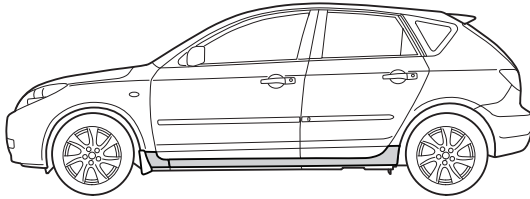

MAZDA 5 CR1

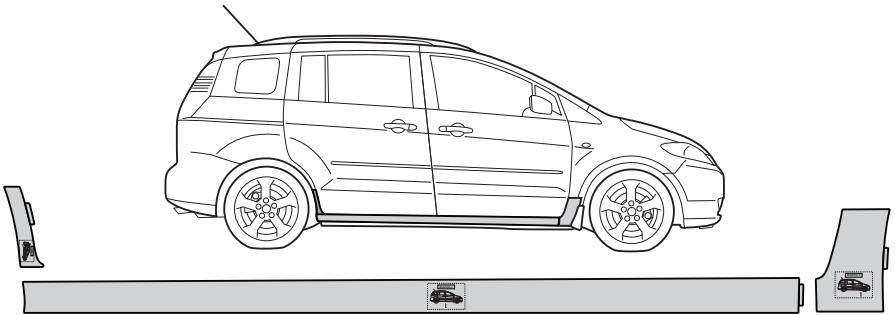
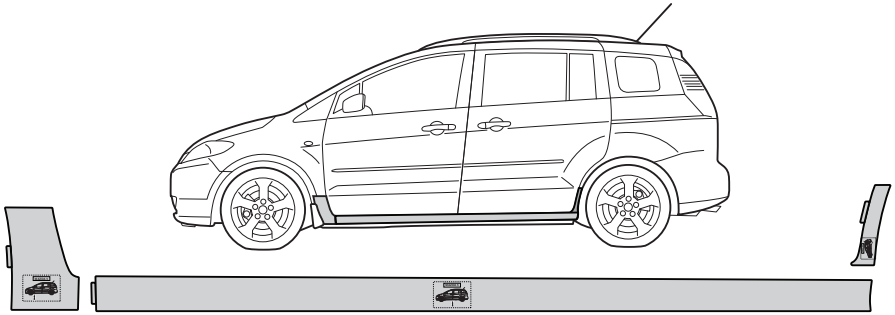

MAZDA 6 GG, GY, GG1

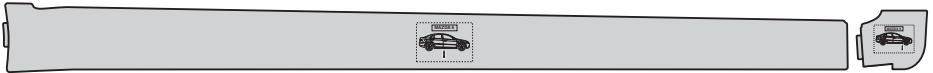
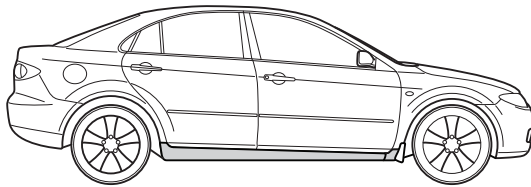
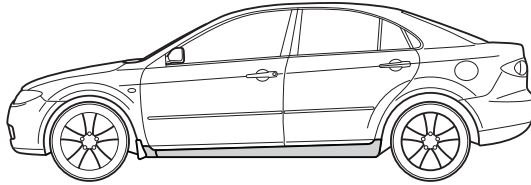

CX-7 ER

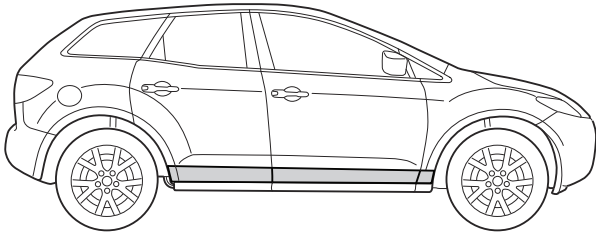
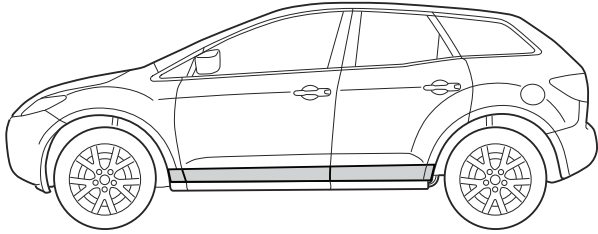

1

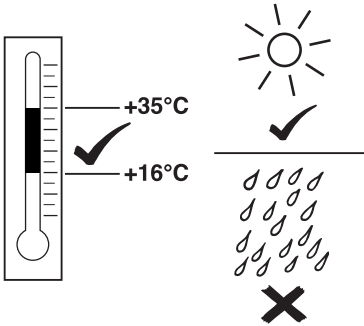

A diagram showing a thermometer with a checkmark next to the +35°C mark and a cross next to the +16°C mark. To the right, a sun icon has a checkmark, and a rain cloud icon has a cross.

+35°C ✓
+16°C ✗

2



A line drawing of a car's side profile. A hand is shown washing the lower part of the door with a sponge. An inset shows a hand holding a bottle of cleaner and spraying it onto the sponge. The word "CLEANER" is written below the inset.

CLEANER

3



A hand is shown pouring liquid from a bottle labeled "SOAP" into a bucket of water. A hand is also shown turning a faucet. A box labeled "5L : 1" is next to the bucket.

SOAP

5L : 1

4

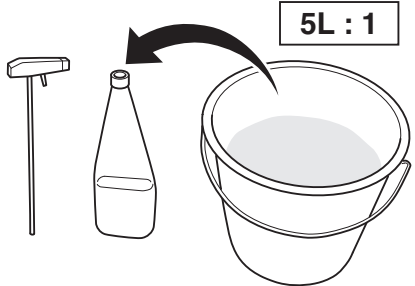

A hand is shown pouring liquid from a bottle into a bucket of water. A box labeled "5L : 1" is next to the bucket.

5L : 1

5

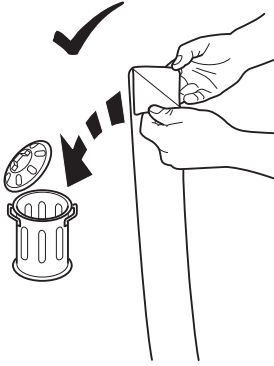

A hand is shown pouring liquid from a bottle into a trash can. A checkmark is next to the action.

✓

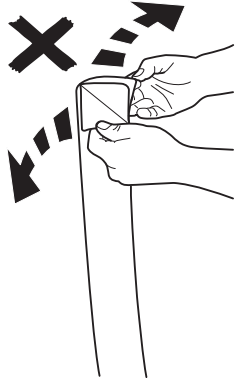

A hand is shown pouring liquid from a bottle into a trash can. A cross is next to the action.

✗

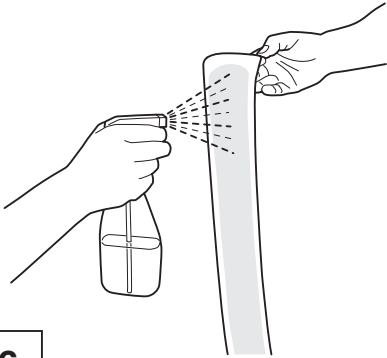

6

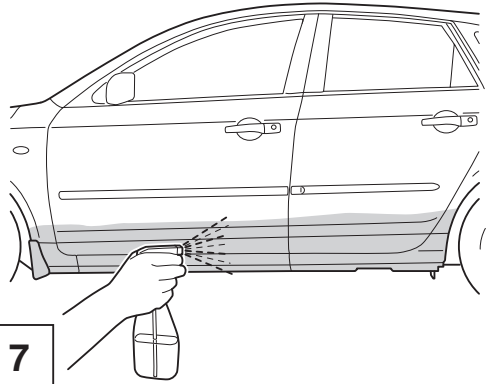

7

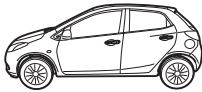

MAZDA 2 DE



9-11

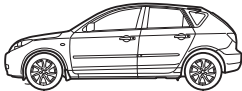

MAZDA 3 BK



12-14



MAZDA 5 CR1



15-17

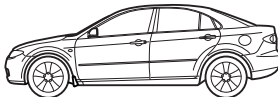

MAZDA 6 GG, GY, GG1



18-20

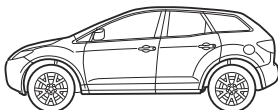

CX-7 ER



21-22

8

MAZDA 2 DE

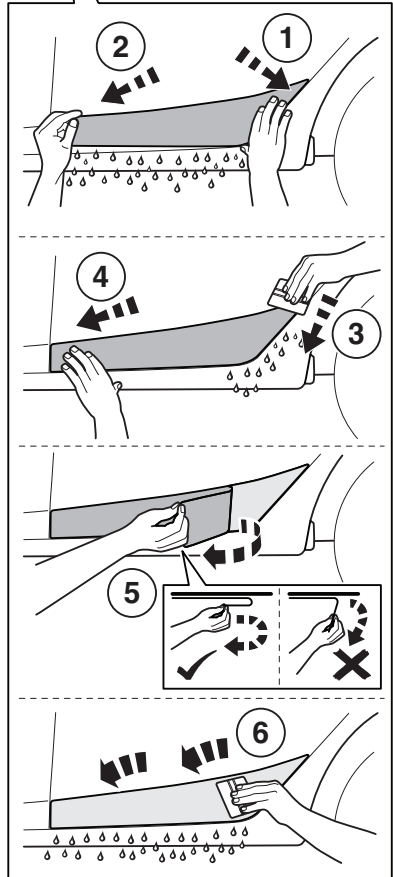
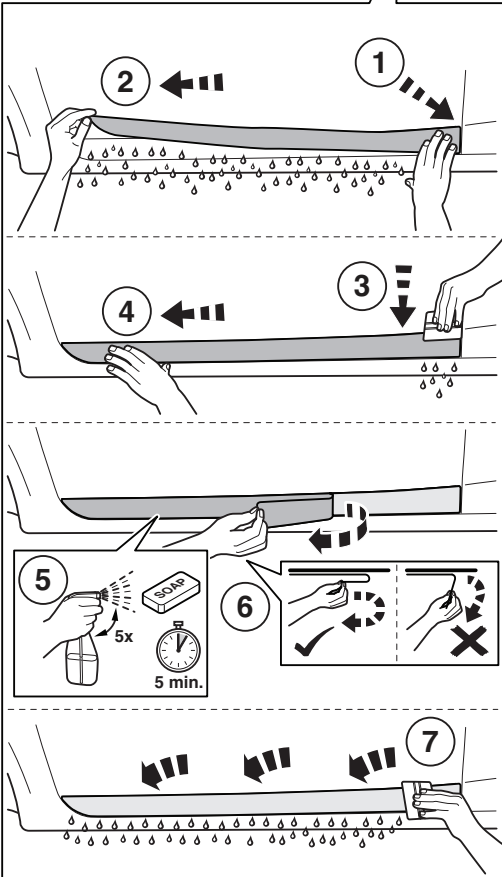
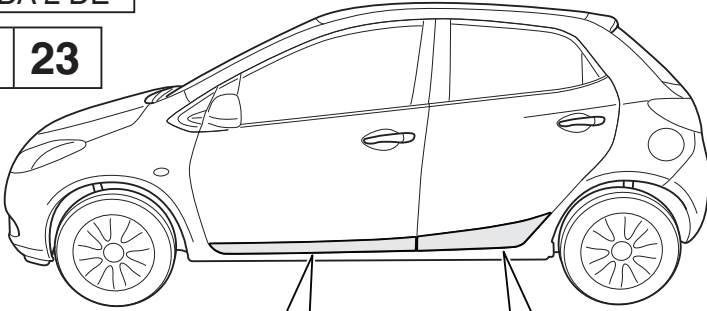

MAZDA 2 DE



23

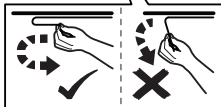
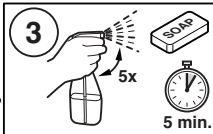
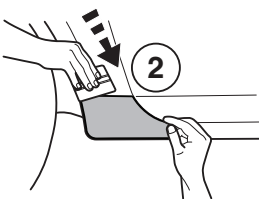
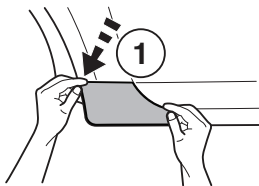
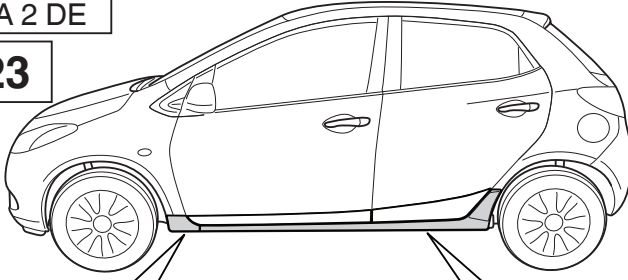

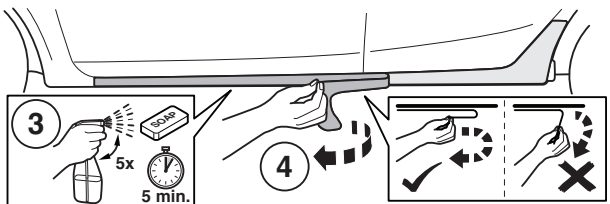
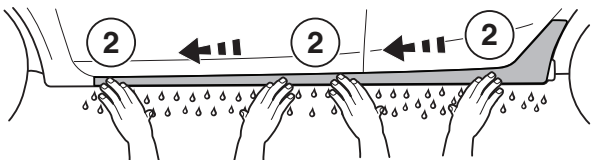
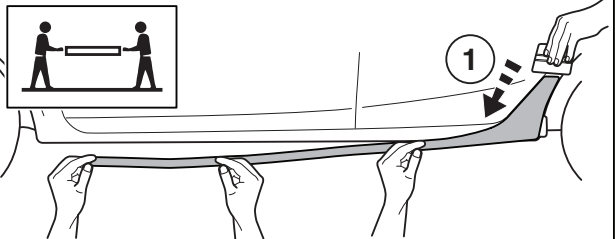
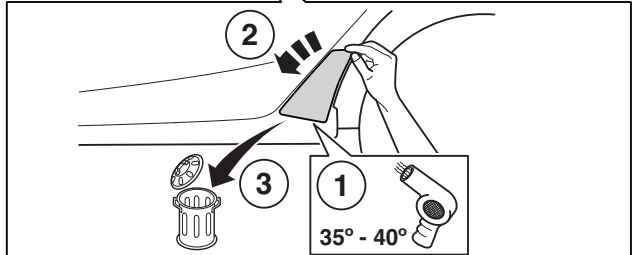

10

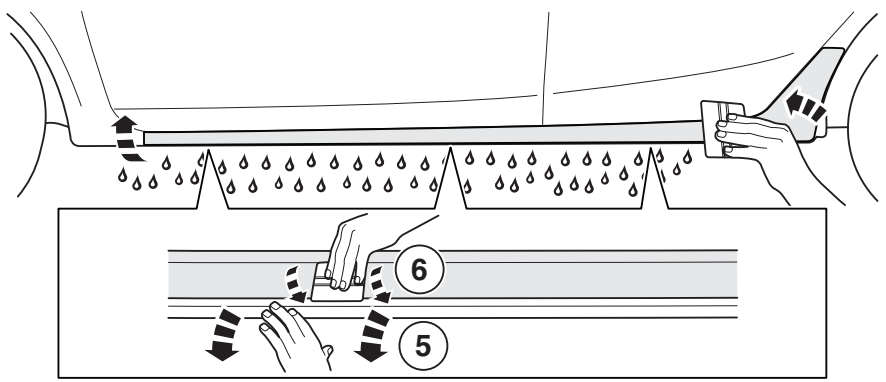
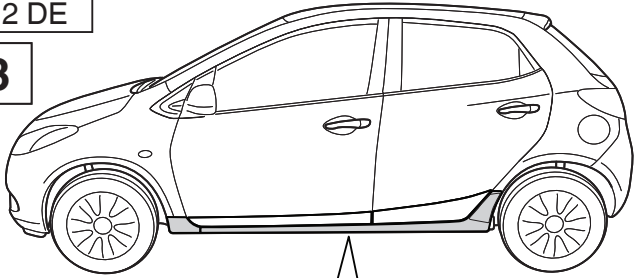

MAZDA 2 DE

 **23**



 **7**
35° - 40°

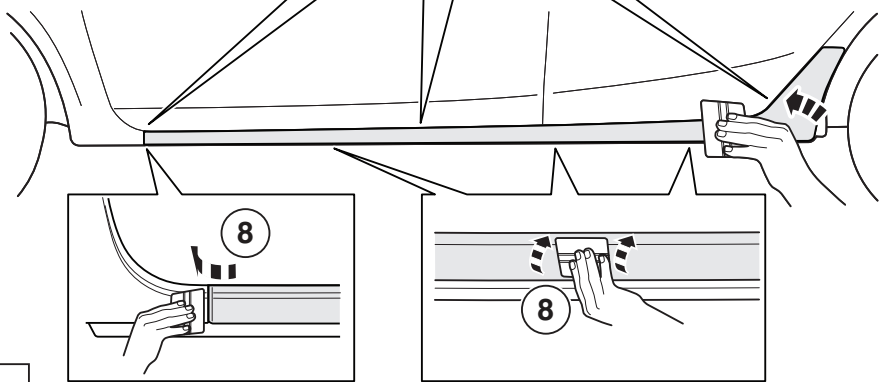

MAZDA 3 BK

 **23**

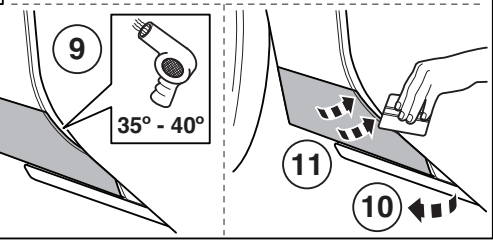
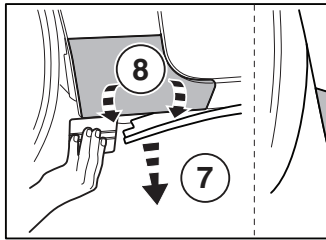
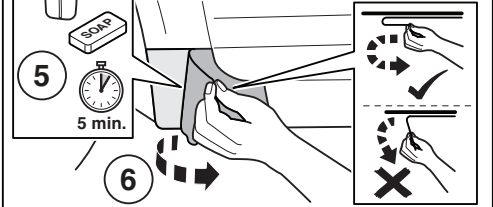
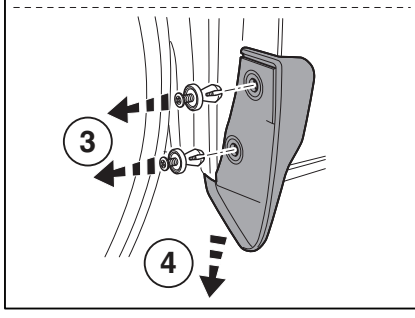
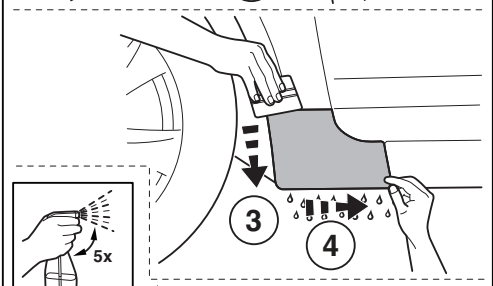
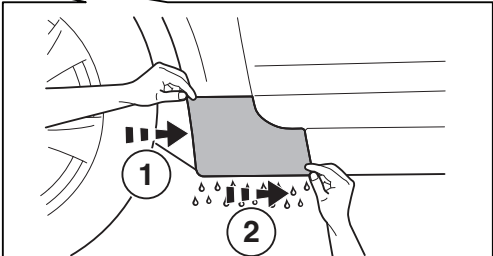
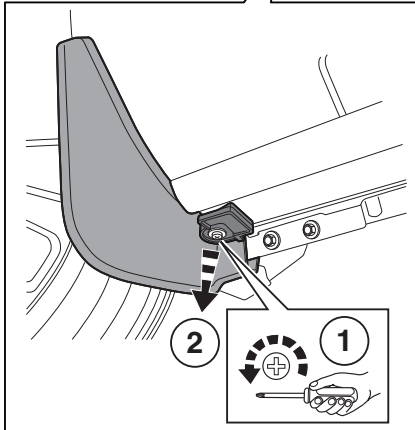
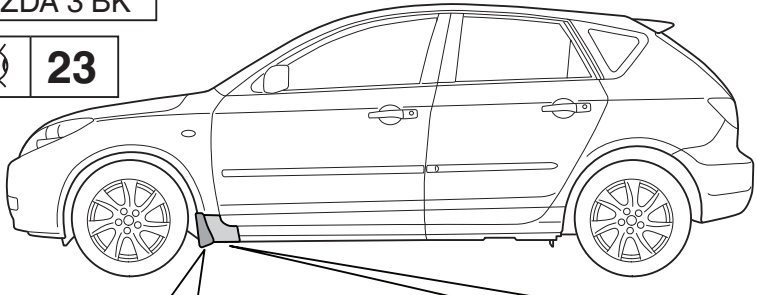

12

MAZDA 3 BK

 **23**

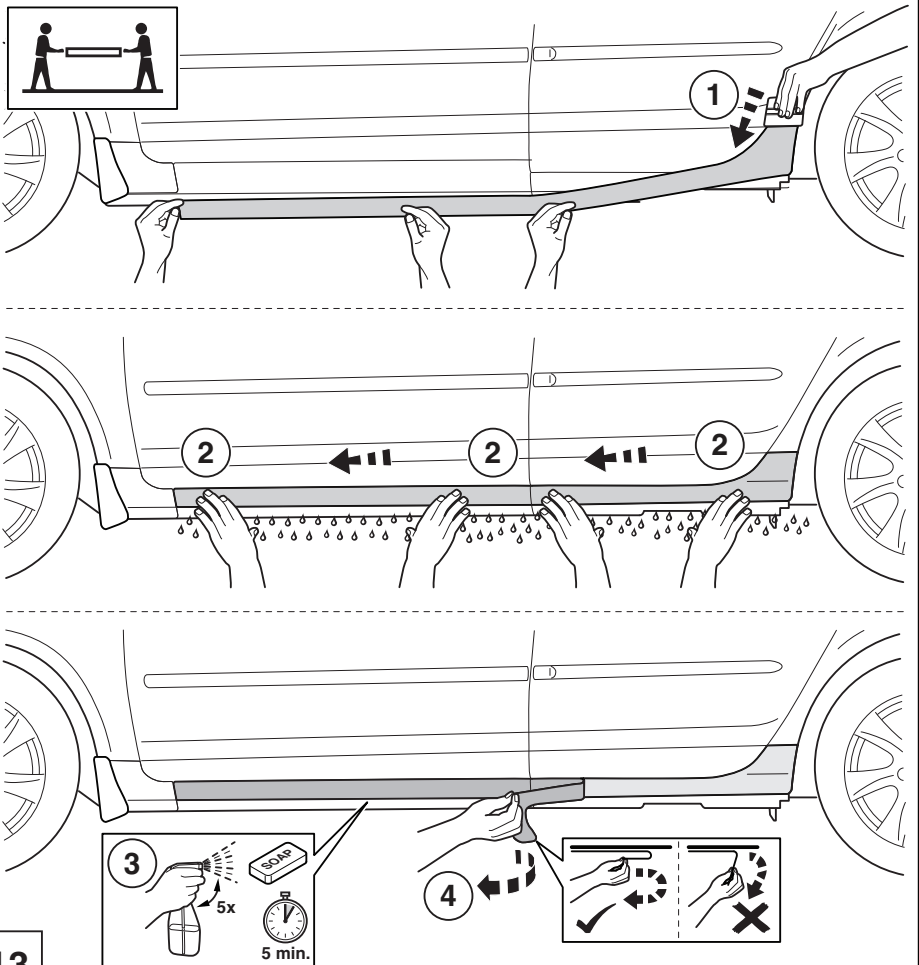
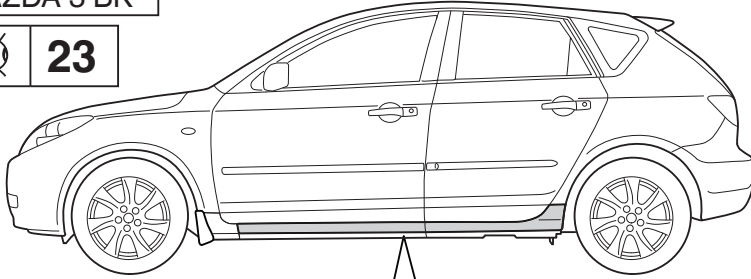

MAZDA 3 BK

 **23**

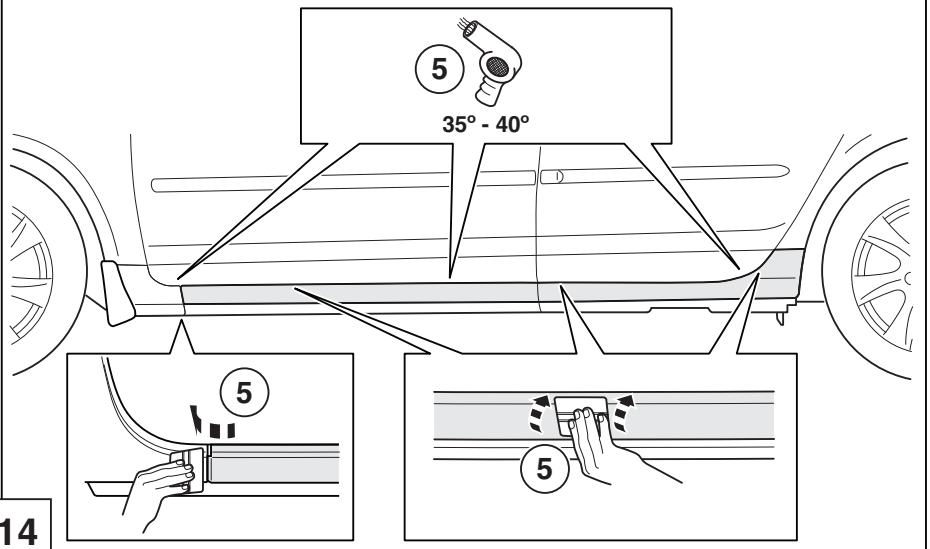
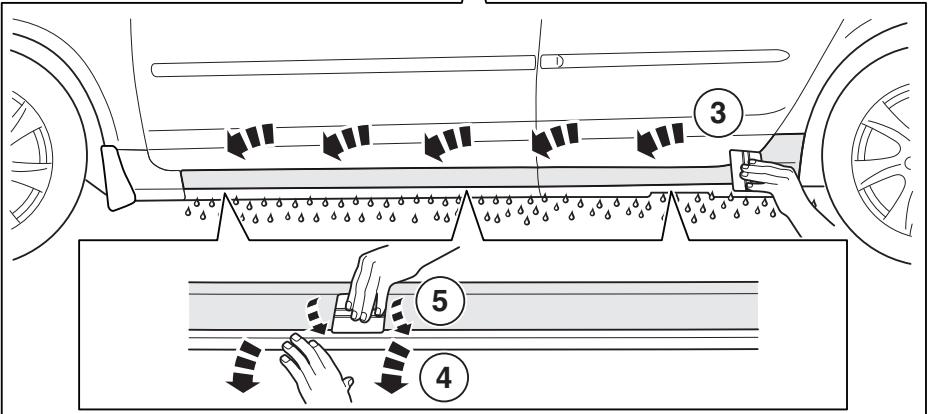
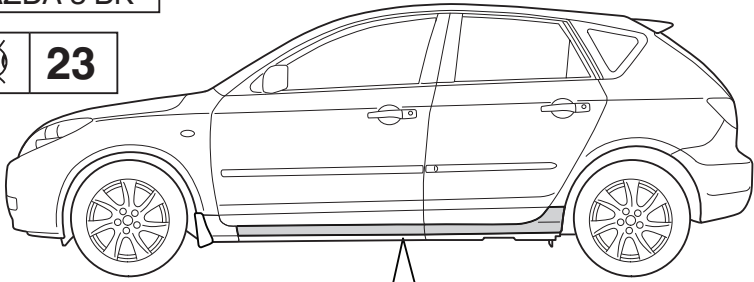

MAZDA 5 CR1



23

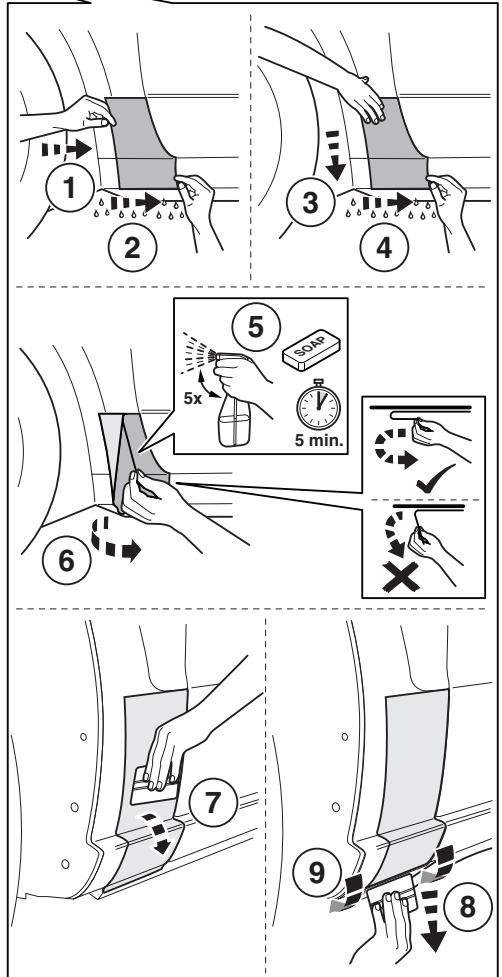
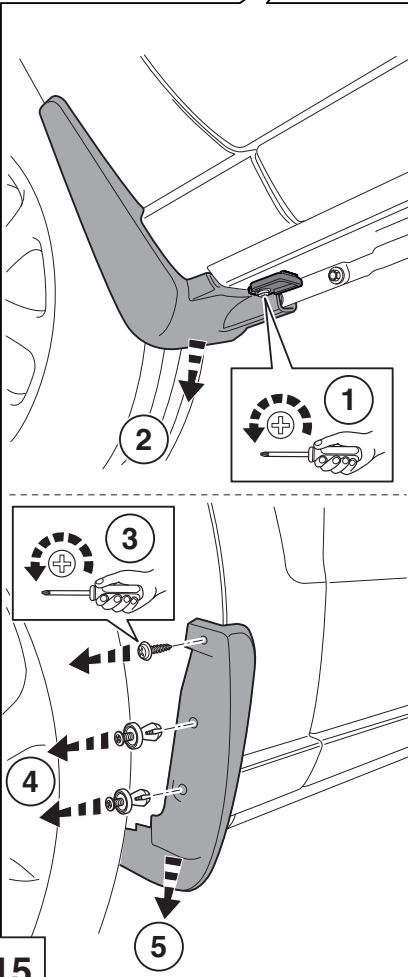
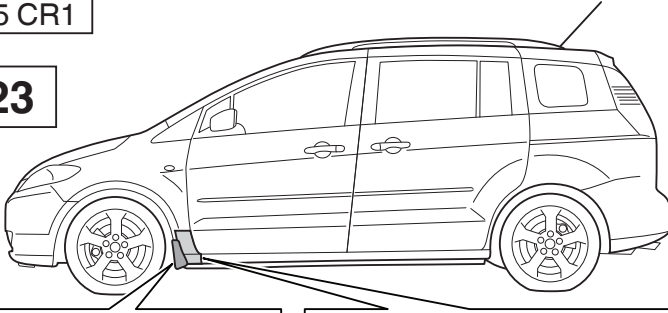

MAZDA 5 CR1

 **23**

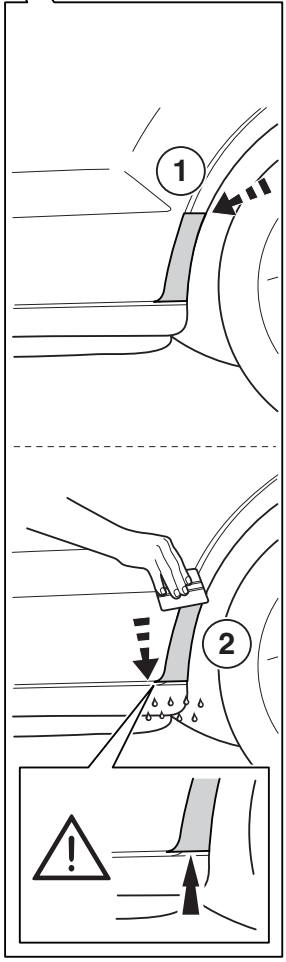
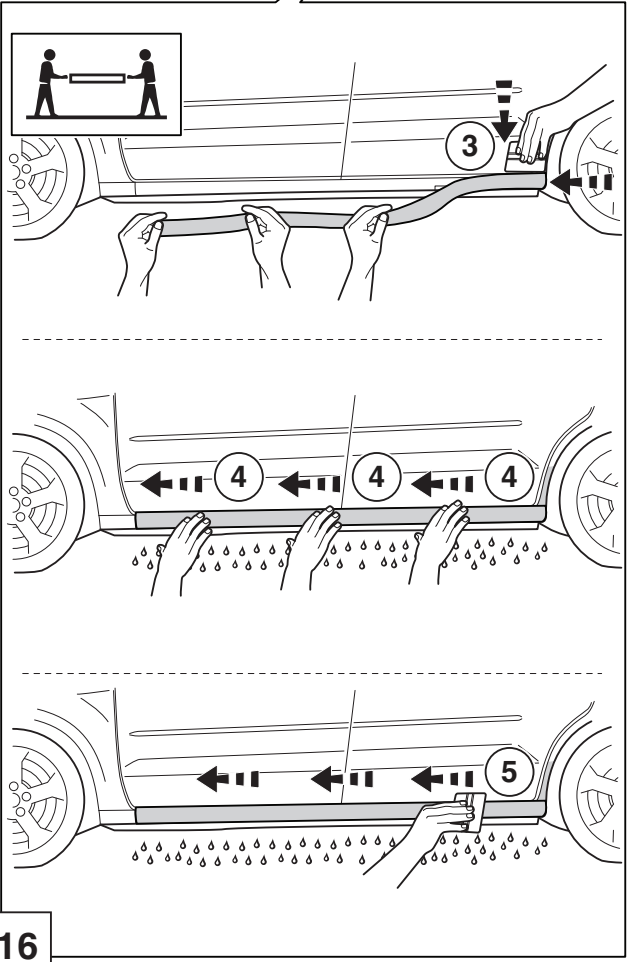
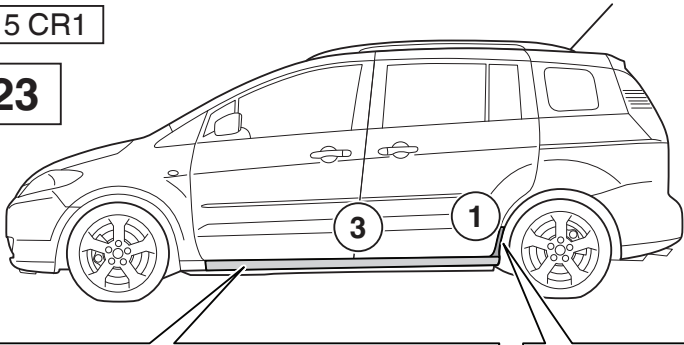

MAZDA 5 CR1

 **23**

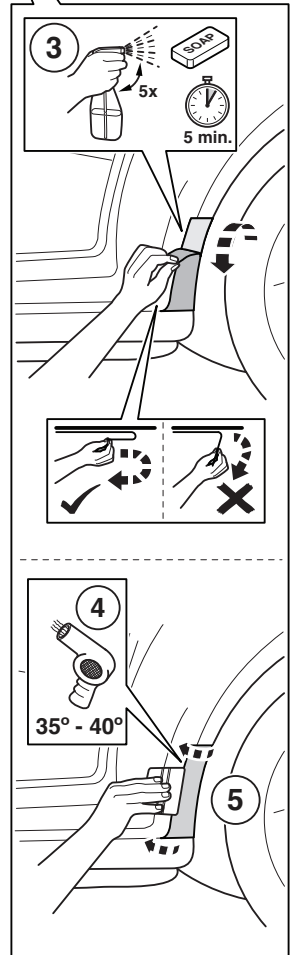
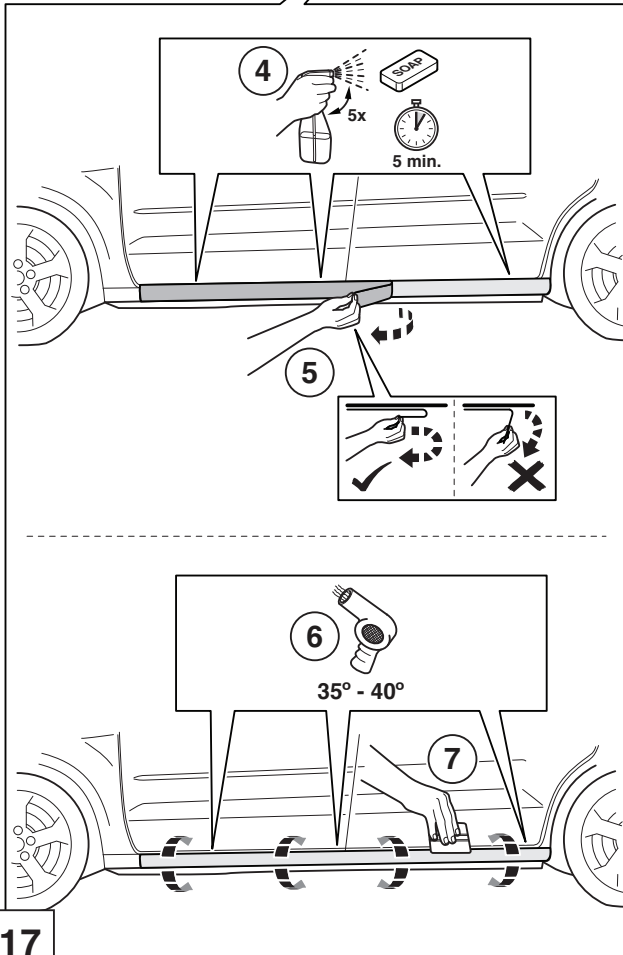
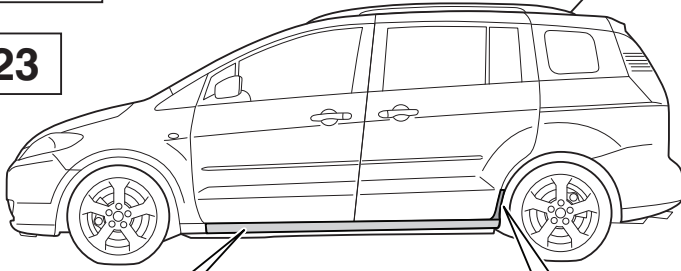

MAZDA 6 GG, GY, GG1

 **23**

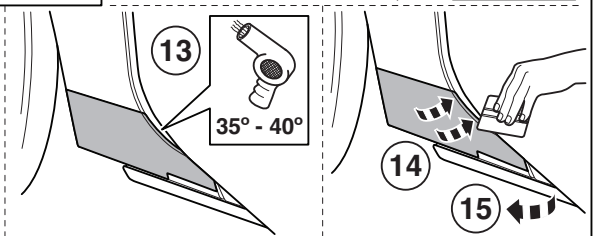
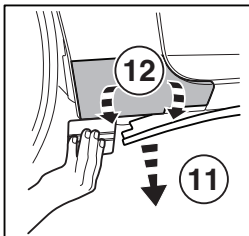
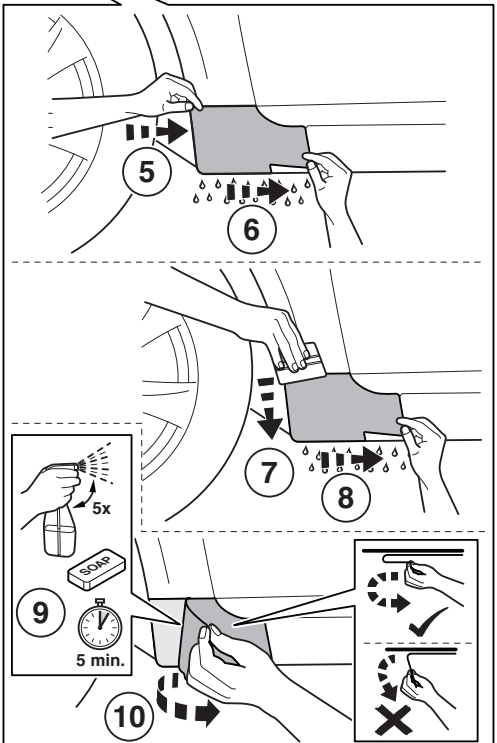
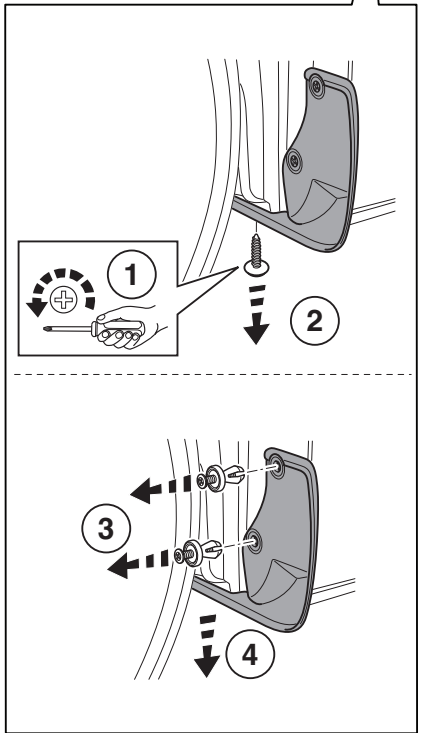
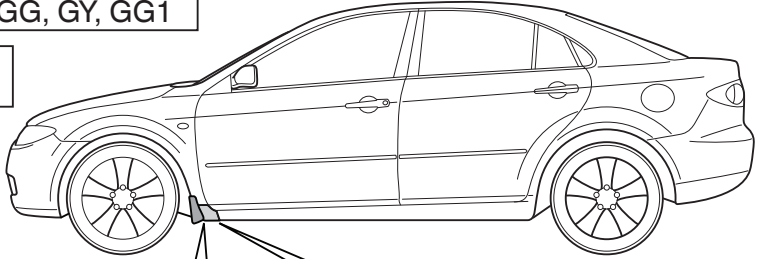

MAZDA 6 GG, GY, GG1



23

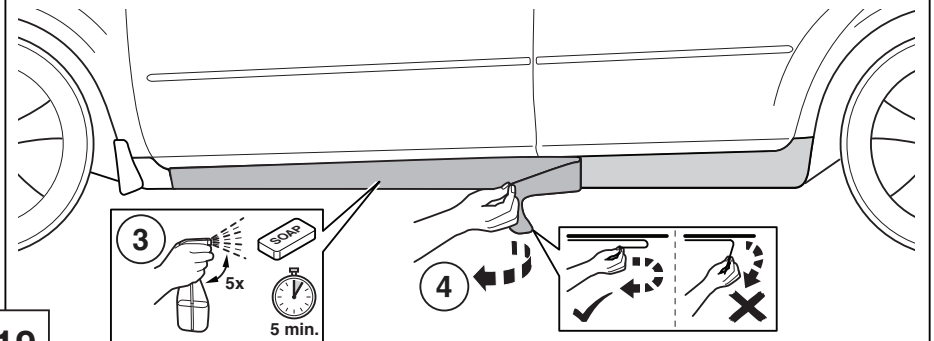
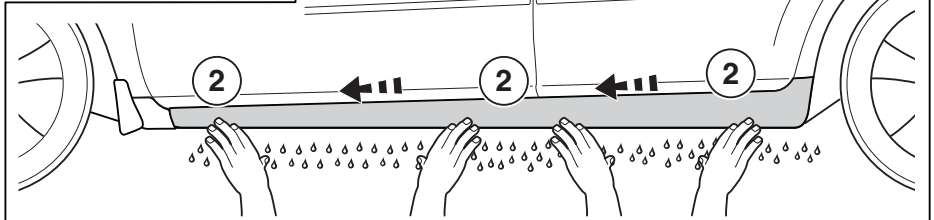
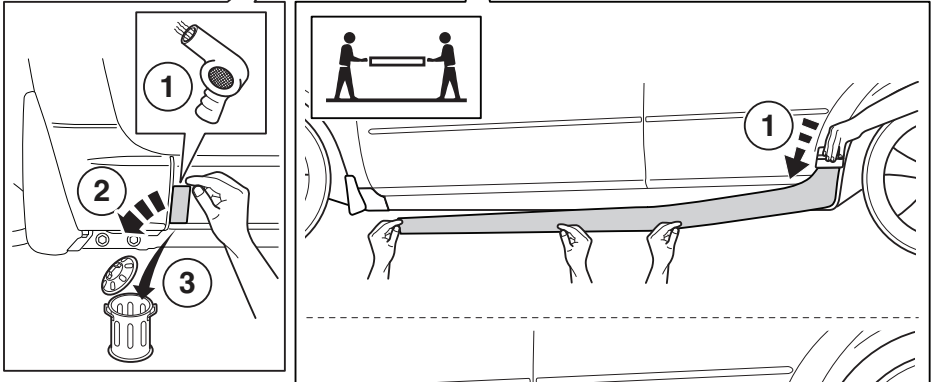
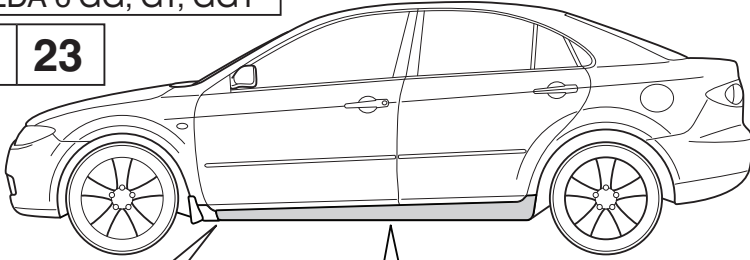

19

MAZDA 6 GG, GY, GG1



23

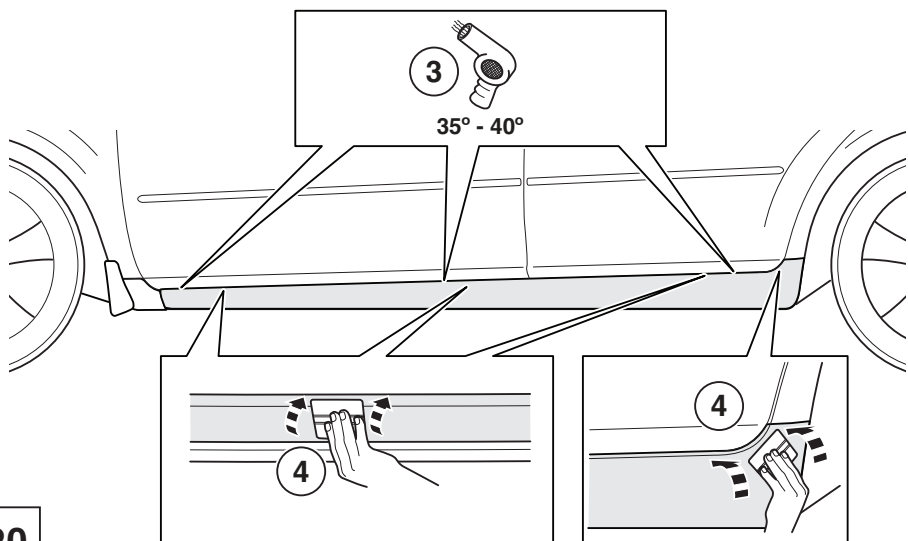
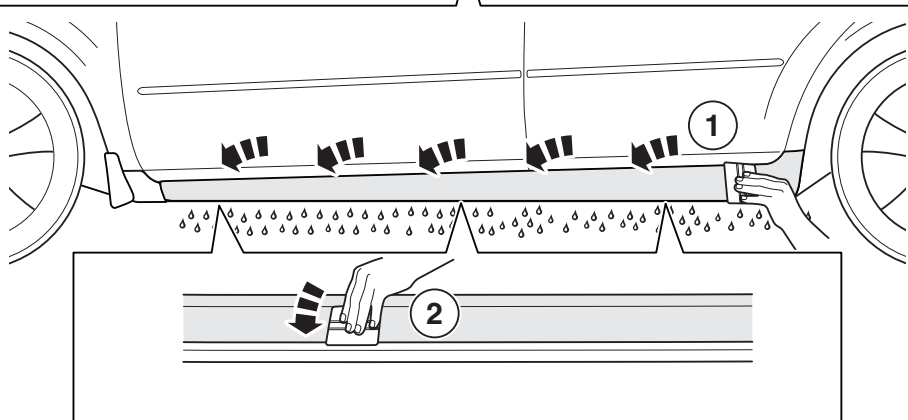
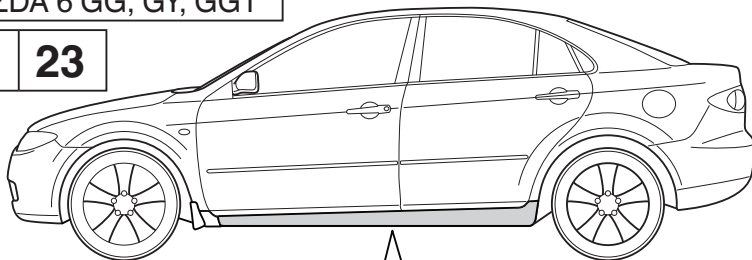

20

CX-7 ER



23

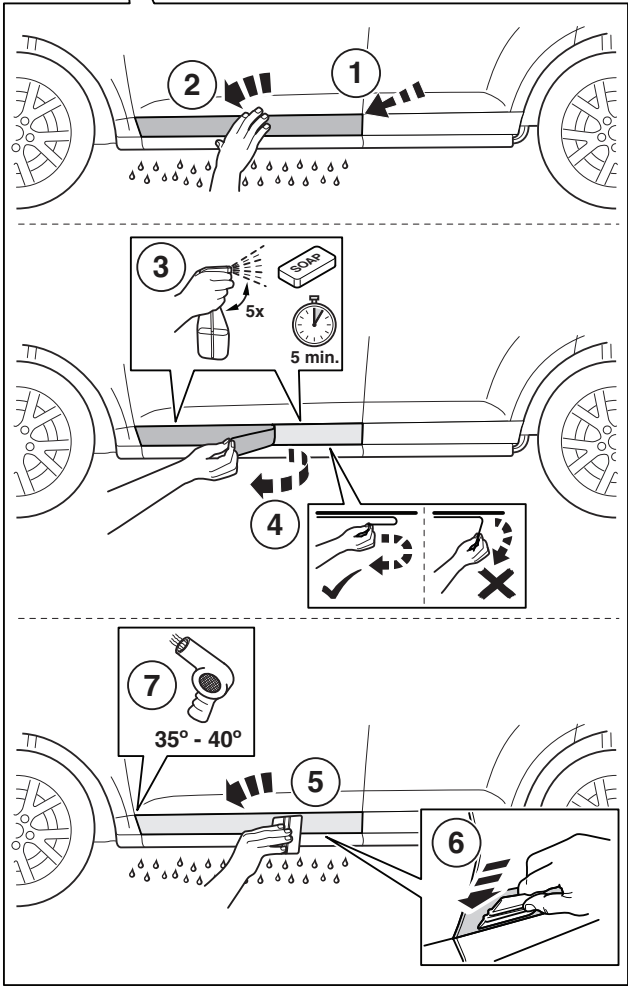
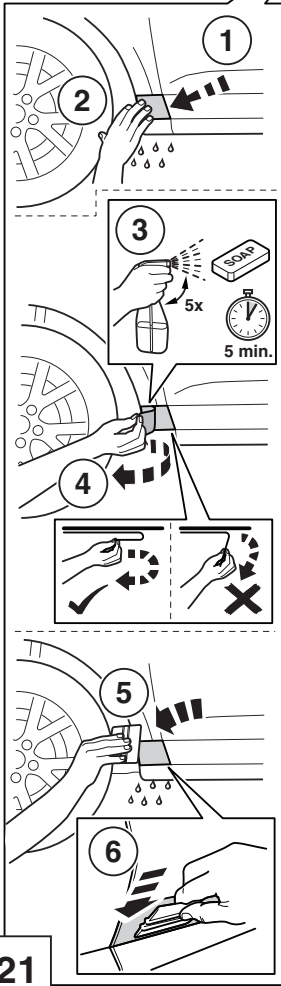
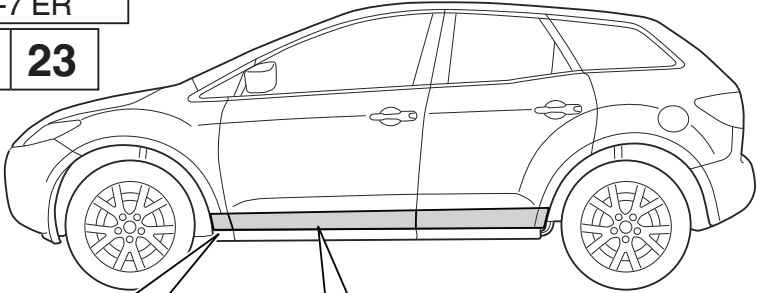

CX-7 ER



23

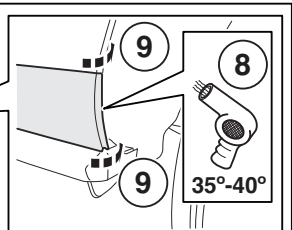
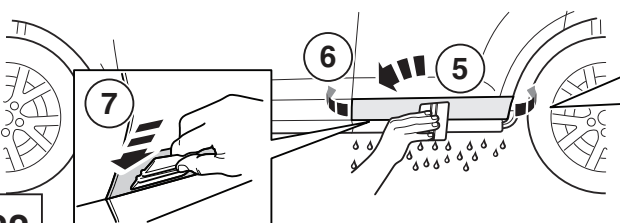
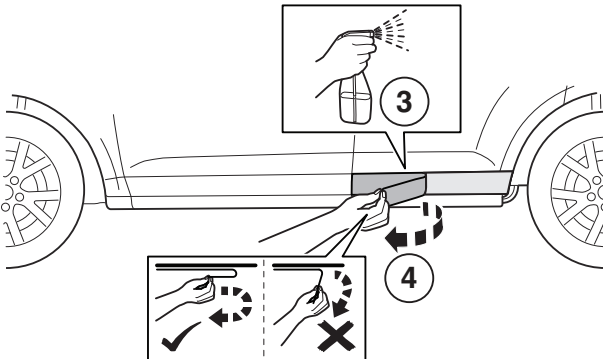
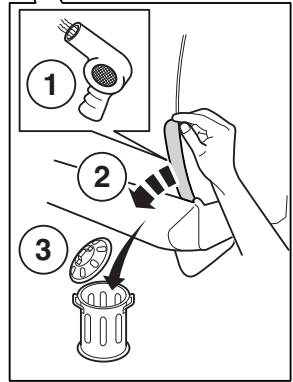
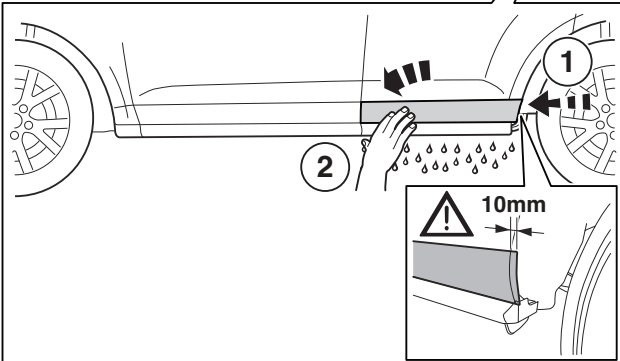
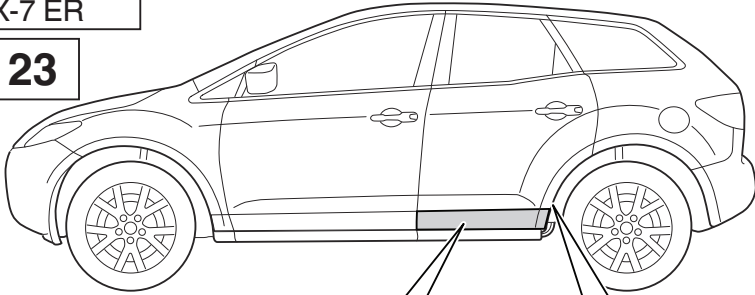

22

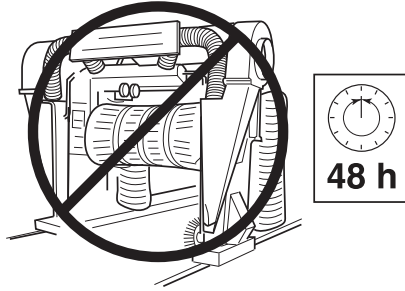

23