

MAZDA

GB DOG GUARD Installation instruction	N HUNDEBESKYTTELSE Monteringsvejledning
D HUNDESCHUTZGITTER Einbauanleitung	S HUNDSKYDD Monteringsanvisning
E PROTECCIO CONTRA PERRO Instrucciones de montaje	SF KOIRAVERKKO Asennusohje
F GRILLE A CHIEN Notice de montage	CZ MŘÍŽ PRO PŘEVOZ PSŮ Návod k montáži
I PROTEZIONE PER CANE Istruzioni di montaggio	H FÉLMAGAS KUTYARÁCS Beszerelési utasítás
P PROTECÇÃO PARA CÃES Instruções de montagem	PL PRZEGRODA ODDZIELAJĄCA DLA PSA Instrukcja zabudowy
NL HONDEREK Inbouw-instructie	GR ΠΛΕΓΜΑ ΠΡΟΣΤΑΣΙΑΣ ΣΚΥΛΩΝ Οδηγίες τοποθέτησης
DK HUNDEBESKYTTELSE Monteringsvejledning	RUS Защитная сетка для собак инструкция по установке

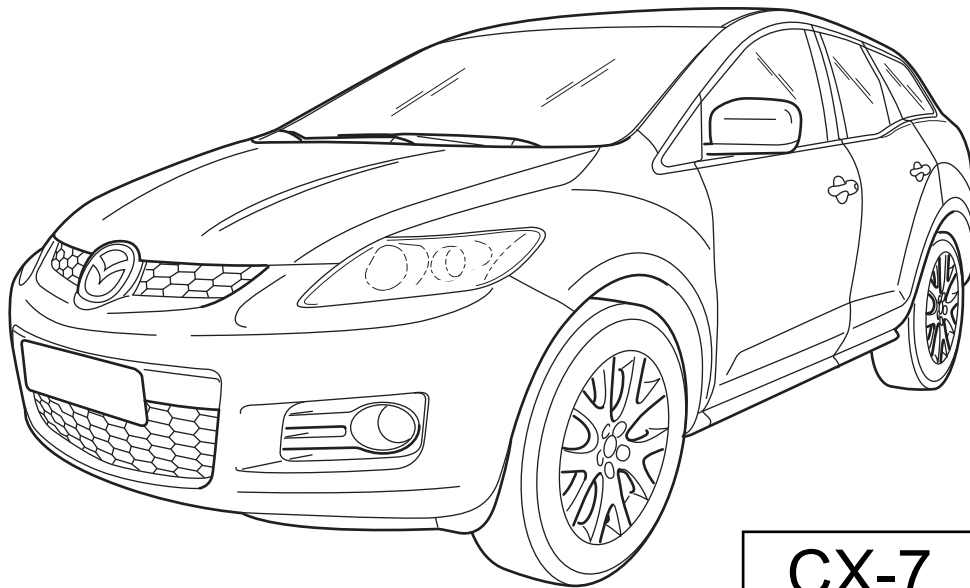

CX-7

ER

Part Number: EH62-V1-280
EH62-V1-285

Date: 11-05-2010

© Copyrights MAZDA

Sheet 1 of 8

Expert Fitment Required
Montage durch Fachwerkstatt erforderlich
Montaje sólo por el concesionario
Montage par spécialiste nécessaire
E' necessario in officina specializzata
Especialista em montagem requerido
Montage door vakman nodig
Montage ved professionelt værksted påkrævet
Nødvendig med montering fra fagvejværksted
Verkstadsmontage erfordras
Asennus tarpeen merkkikorjaamossa
Montáž ve specializované dílně nutná
A szereléshez szakműhely kell
Konieczny montaż przez warsztat specjalistyczny
Na τοποθετεί από συνεργείο
Необходима установка специалистами



- (GB)** Warning
- (D)** Achtung
- (E)** Atención
- (F)** Attention
- (I)** Attenzione
- (P)** Atenção
- (NL)** Let op
- (DK)** Bemærk
- (N)** Pass på
- (S)** Varning
- (SF)** Huomio
- (CZ)** Pozor
- (H)** Figyelem
- (PL)** Uwaga
- (GR)** Προσχή
- (RUS)** Осторожно

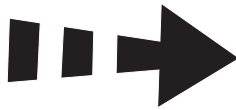

- (GB)** Movement Arrow
- (D)** Bewegungspfeil
- (E)** Flecha de movimiento
- (F)** Flèche indiquant sens du mouvement
- (I)** Freccia di movimento
- (P)** Flexa de movimento
- (NL)** Richtingspijl
- (DK)** Bevægelsespil
- (N)** Bevegelsespil
- (S)** Rörelsepil
- (SF)** Liikesuuntanuoli
- (CZ)** Šipka pohybu
- (H)** Mozgásirányjelző nyíl
- (PL)** Strzałka kierunku ruchu
- (GR)** Βέλος κίνησης
- (RUS)** Стрелка по направлению



- (GB)** Location
- (D)** Positionspfeil
- (E)** Flecha de posición
- (F)** Flèche indiquant location
- (I)** Freccia di posizione
- (P)** Flexa de posição
- (NL)** Lokatie
- (DK)** Lokaliseringspil
- (N)** Posisjonspil
- (S)** Positionpil
- (SF)** Paikannusnuoli
- (CZ)** Šipka na pozici
- (H)** Helyzetjelző nyíl
- (PL)** Strzałka położenia
- (GR)** Βέλος θέσης
- (RUS)** Позиция

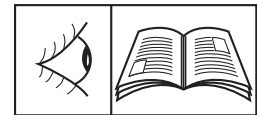

- (GB)** See Workshop Manual
- (D)** Siehe Werkstatthandbuch
- (E)** Ver manual de taller
- (F)** Voir Manuel d'atelier
- (I)** Vedere manuale officina
- (P)** Cf. o manual da oficina
- (NL)** Zie werkplaatshandboek
- (DK)** Se værkstedshåndbog
- (N)** Se verkstedshåndboka
- (S)** Se verkstadshandboken
- (SF)** Katso korjaamon käsikirjasta
- (CZ)** Viz dílenskou příručku
- (H)** Lásd a Műhely-kézikönyvből
- (PL)** Patrz podręcznik warsztatowy
- (GR)** λείπε Εγχειρίδιο Συνεργείου
- (RUS)** Смотри руководство для мастерской





- (GB)** Throw away
- (D)** Entsorgen
- (E)** Tratamiento de residuos
- (F)** Rebuter
- (I)** Smaltire
- (P)** Eliminar
- (NL)** Weggooien
- (DK)** Affald
- (N)** Avskaffe
- (S)** Ta hand om avfallet
- (SF)** Hävittää
- (CZ)** Vyhodit
- (H)** Távolítsa el
- (PL)** Usunąć jako odpad
- (GR)** Απόσυρση
- (RUS)** Выбросите



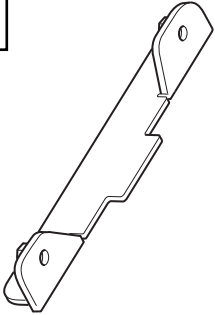
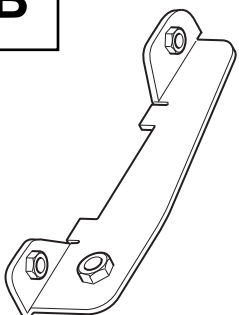
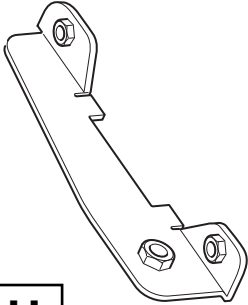
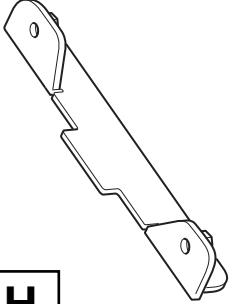
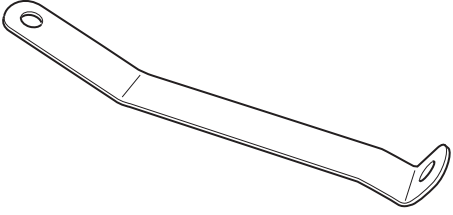

- (GB)** Use Drill
- (D)** Bohrer verwenden
- (E)** Utilizar broca
- (F)** Utiliser une mèche
- (I)** Utilizzare trapano
- (P)** Utilizar a perfuradora
- (NL)** Boordiameter
- (DK)** Bor anvendes
- (N)** Bruk diameter
- (S)** Använd borrh
- (SF)** Käytä poraa
- (CZ)** Použit vrták
- (H)** Használjon fúrót
- (PL)** Stosować wiertarkę
- (GR)** Χρησιμοποιείτε τρυπάνι
- (RUS)** Используйте дрель

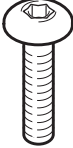
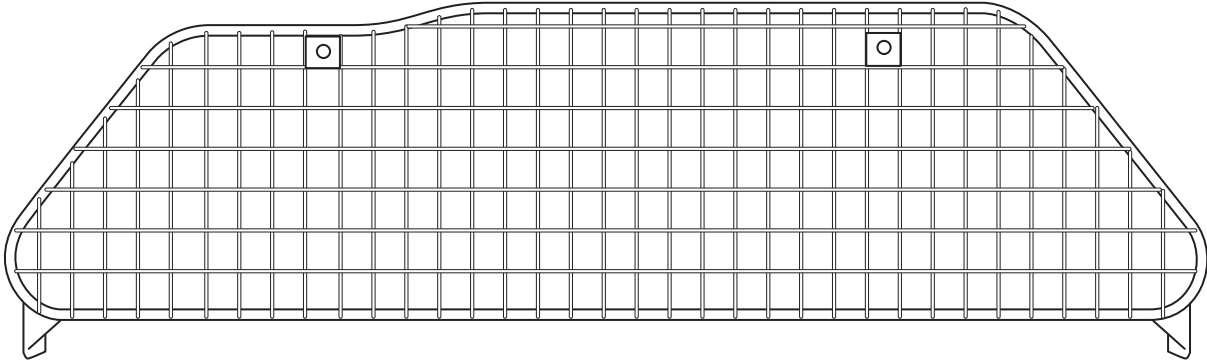
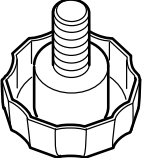
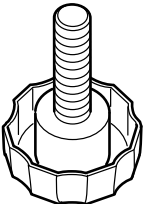
EH62-V1-280

A  RH 1X	B  RH 1X	C  LH 1X	D  LH 1X
E  2x	F  2x	G  4x	
H  1x			
I  4x	J  2x		

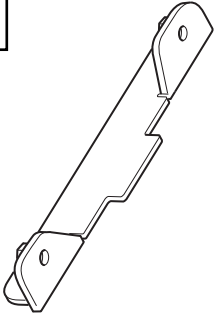
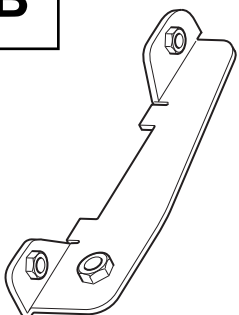
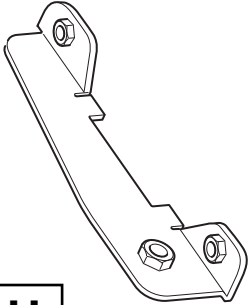
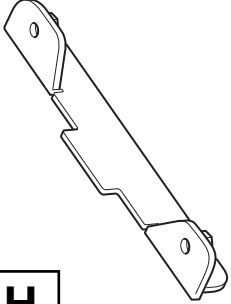
EH62-V1-285

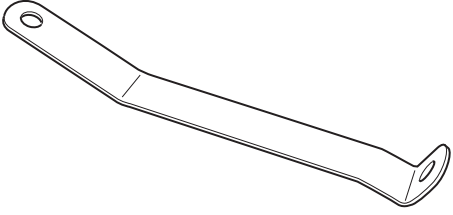
<p>A</p>  <p>RH</p> <p>1X</p>	<p>B</p>  <p>RH</p> <p>1X</p>	<p>C</p>  <p>LH</p> <p>1X</p>	<p>D</p>  <p>LH</p> <p>1X</p>
--	--	---	--

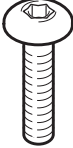
<p>E</p>  <p>2x</p>	<p>F</p>  <p>2x</p>	<p>G</p>  <p>4x</p>
--	--	--

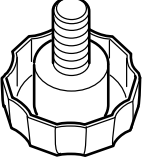
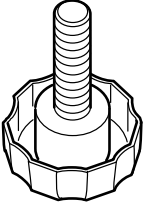
<p>I</p>  <p>4x</p>	<p>J</p>  <p>2x</p>
---	---

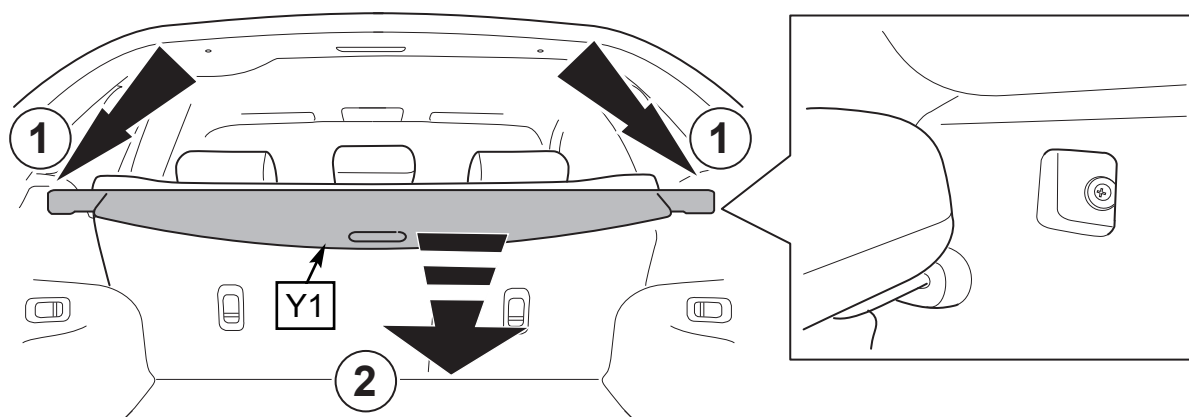
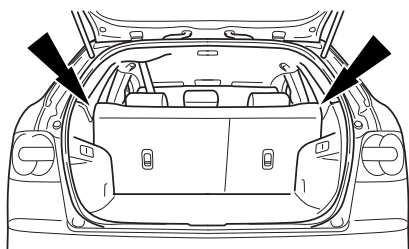

1

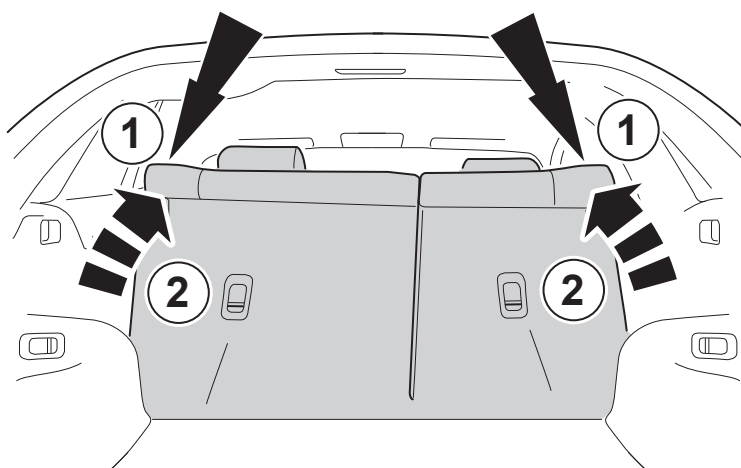
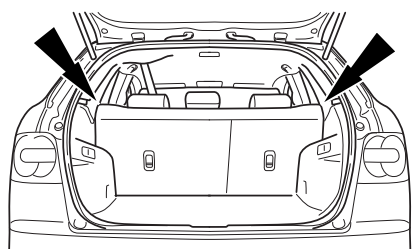

2

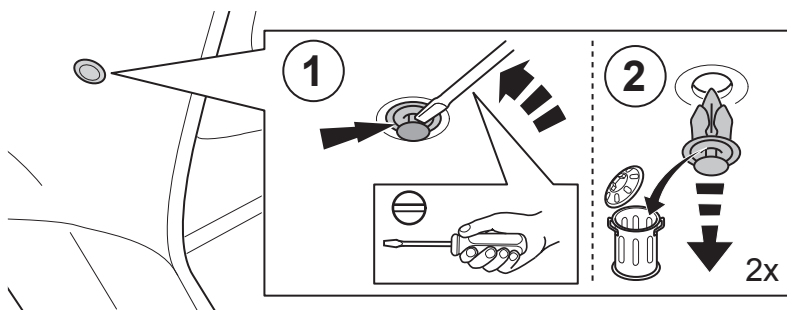
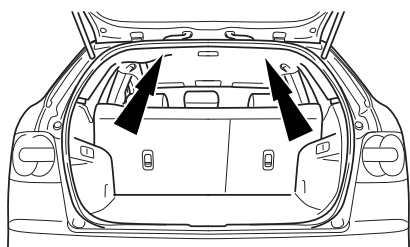

3

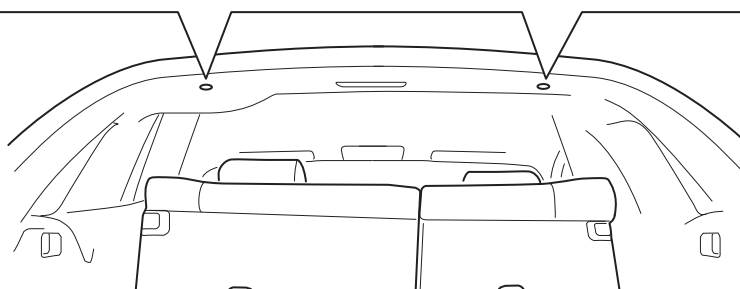

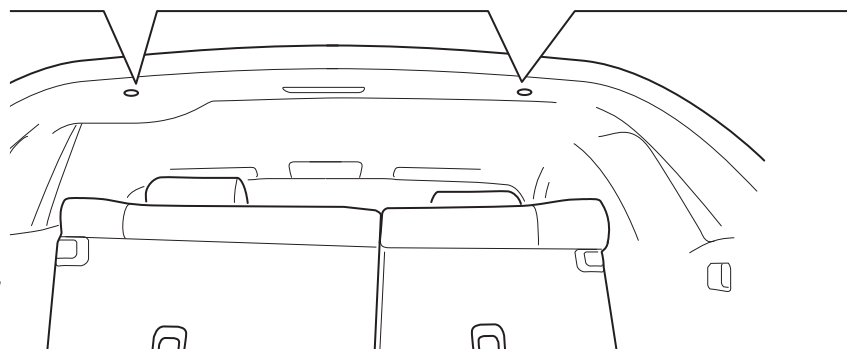
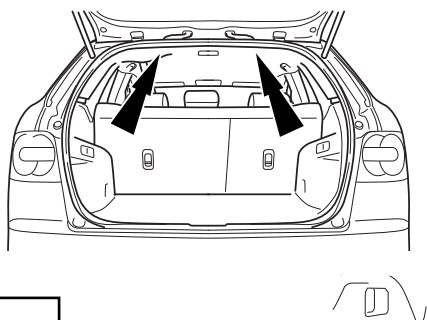
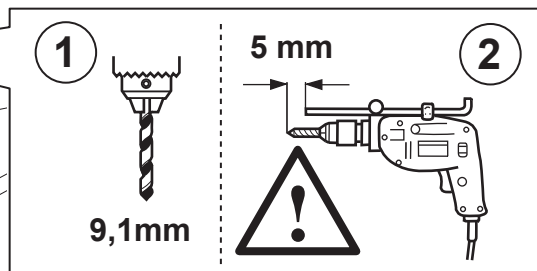
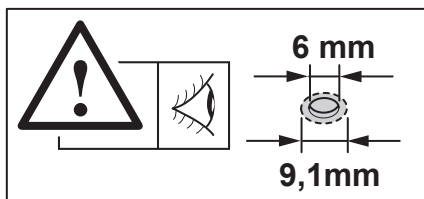

4

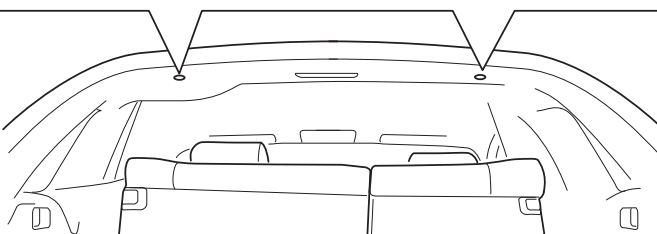
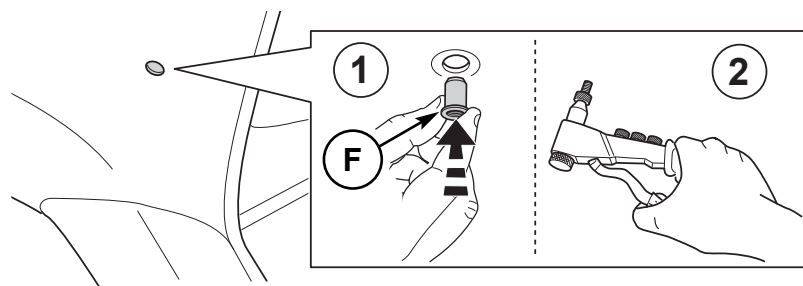
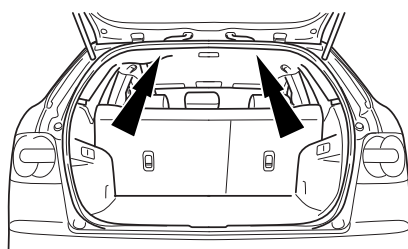

5

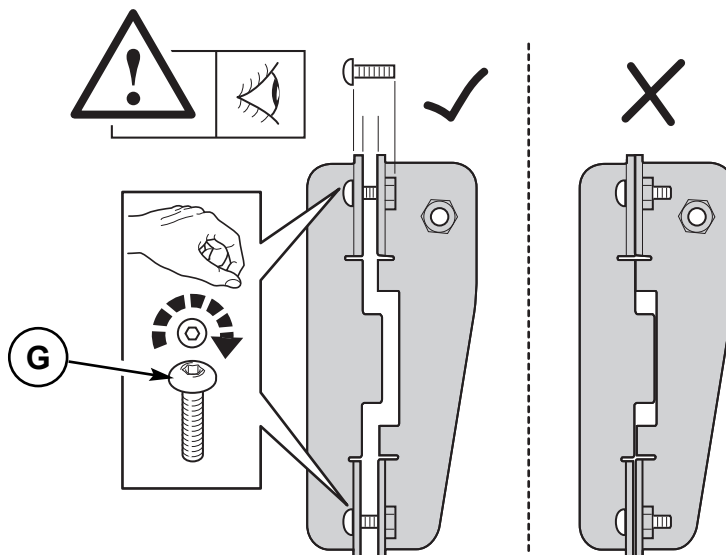
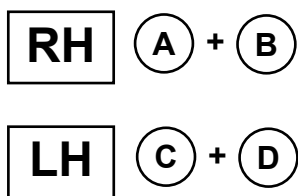

6

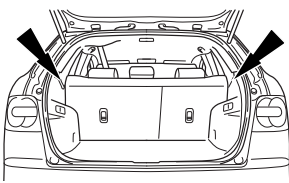
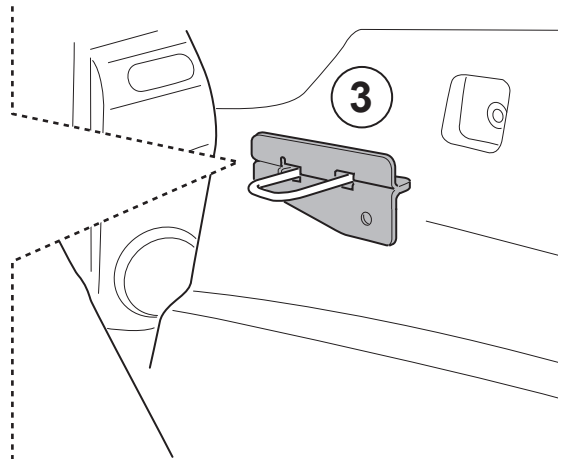
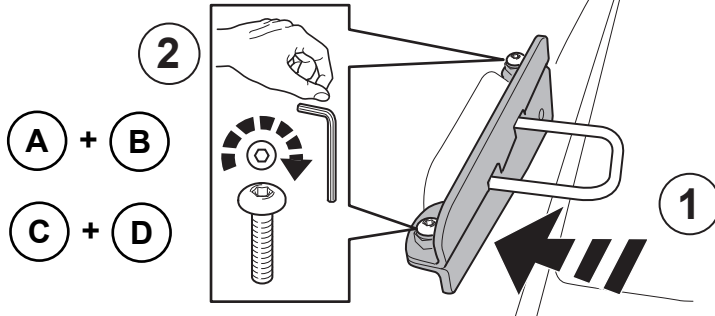

7

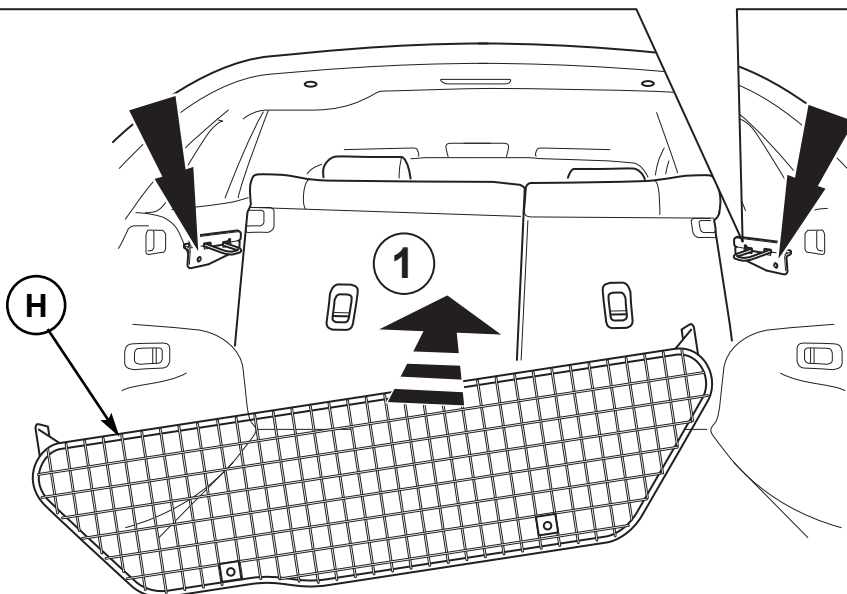
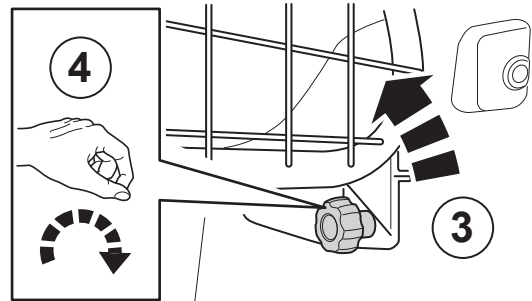
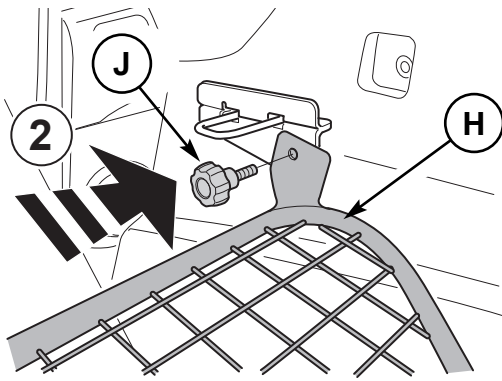

8

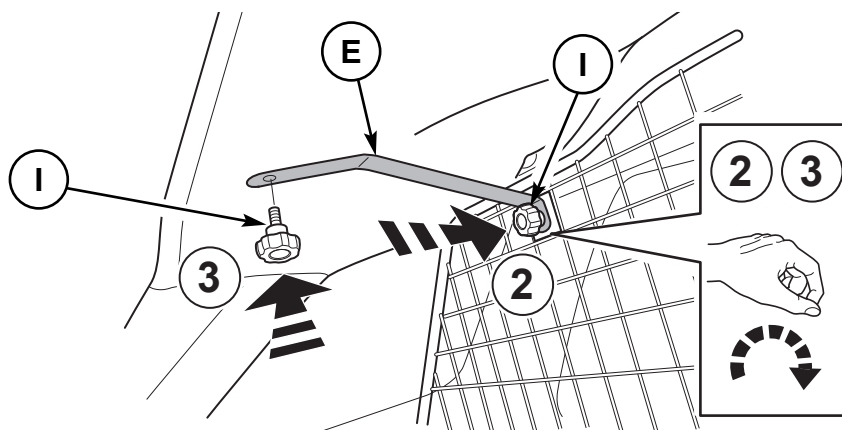

9

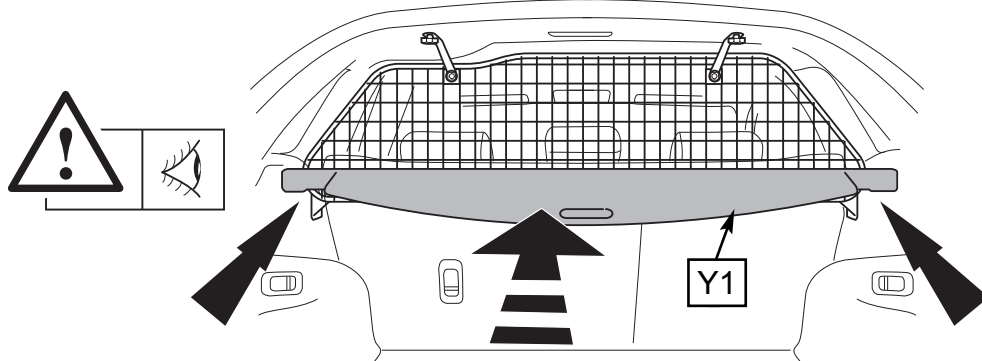
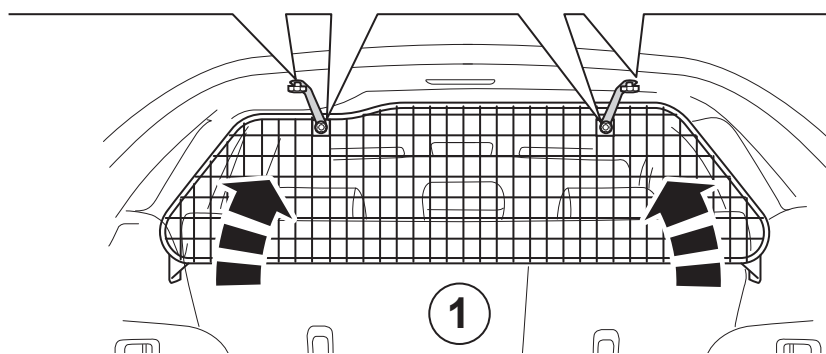

10

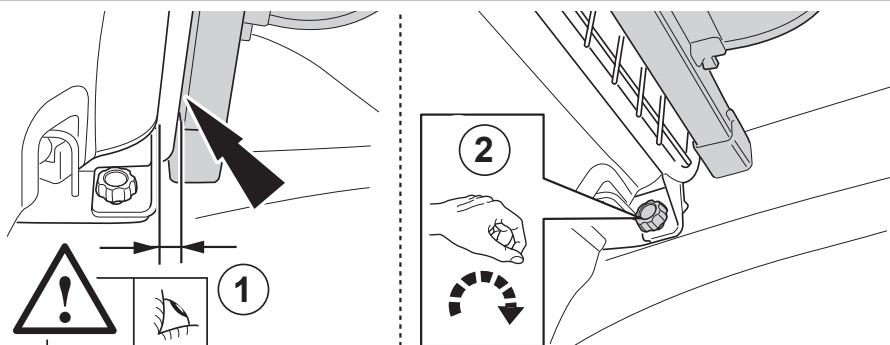

11

