

Description/Beschreibung/Désignation/Descrizione
 Application/Anwendung/Application/Applicazione
 Part Number/Teilenummer/Référence produit/Codice Pezzo

Cargo Step Panel
Legacy Sedan '10MY~
E775EAJ010

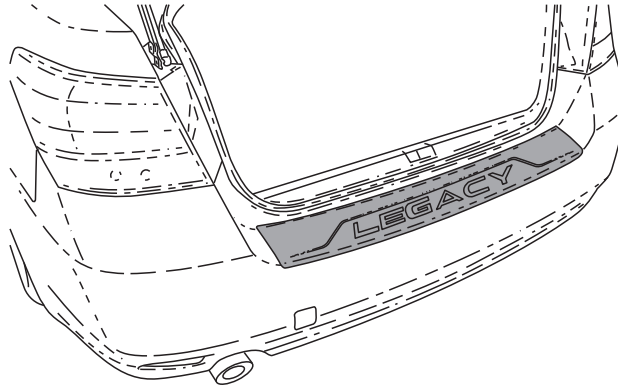

Contents
Inhalt
Contenu
Contenuto

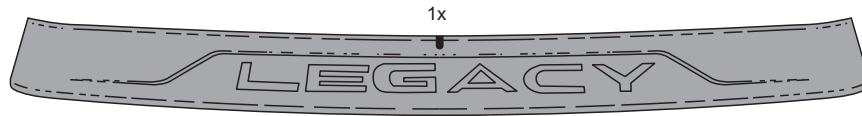

E775EAJ010

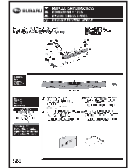

Important
Wichtig
Important
Importante

▲ CAUTION

Indicates potential hazard that could result in vehicle damage.
 Zeigt potentielle Gefahren an, die zu Schäden am Fahrzeug führen können.
 Indique les dangers potentiels pouvant endommager le véhicule.
 Indica potenziale pericolo che può comportare danni all'autovettura.

(GB) Please read this manual and follow the instructions carefully. To emphasize important information, the symbol and words: **▲ CAUTION** and **▲ NOTE** have been used. Pay particular attention to the message highlighted by these signal words.

NOTE: Indicates special information to make maintenance easier or instructions clearer.

(DE) Bitte diese Montageanleitung lesen und die Anweisungen sorgfältig beachten. Zum Hervorheben wichtiger Informationen werden die Symbole und Begriffe **▲ ACHTUNG** und **▲ HINWEIS** benutzt. Achten sie besonders auf den durch die folgenden Begriffe hervorgehobenen Hinweis.

HINWEIS: Markiert spezielle Informationen, um die Wartung zu erleichtern oder Anweisungen zu verdeutlichen.

(FR) Veuillez lire attentivement et respecter ce mode d'emploi et ses instructions. Les symboles et les mots **▲ ATTENTION** et **▲ REMARQUE** sont particulièrement importants et mettent en évidence les informations qui requièrent votre attention

REMARQUE: Donne des informations spécifiques pour faciliter la maintenance ou clarifier les instructions.

(IT) Si prega di leggere il presente manuale e di seguire le istruzioni in esso contenute. Il simbolo e le parole **▲ ATTENZIONE** e **▲ INFORMAZIONE** sono particolarmente importanti e mettono in evidenza informazioni accentuate da tali simboli/parole.

INFORMAZIONE: Indica speciali informazioni per facilitare la manutenzione o per illustrare le istruzioni.

Tools Required
Notwendige Hilfsmittel
Équipement Nécessaire
Attrezzatura Richiesta

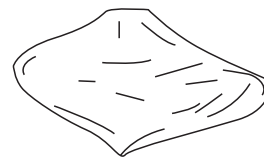
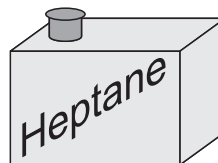



Installation
Montage
Installation
Installazione

1

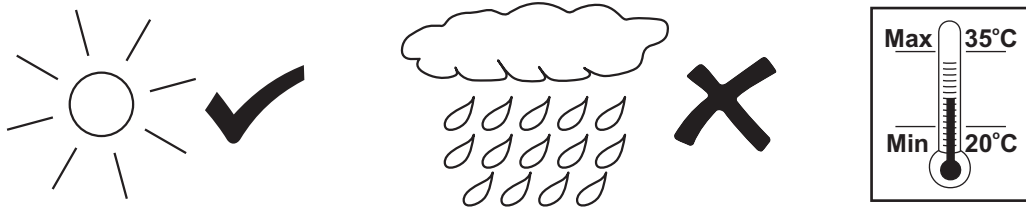

2

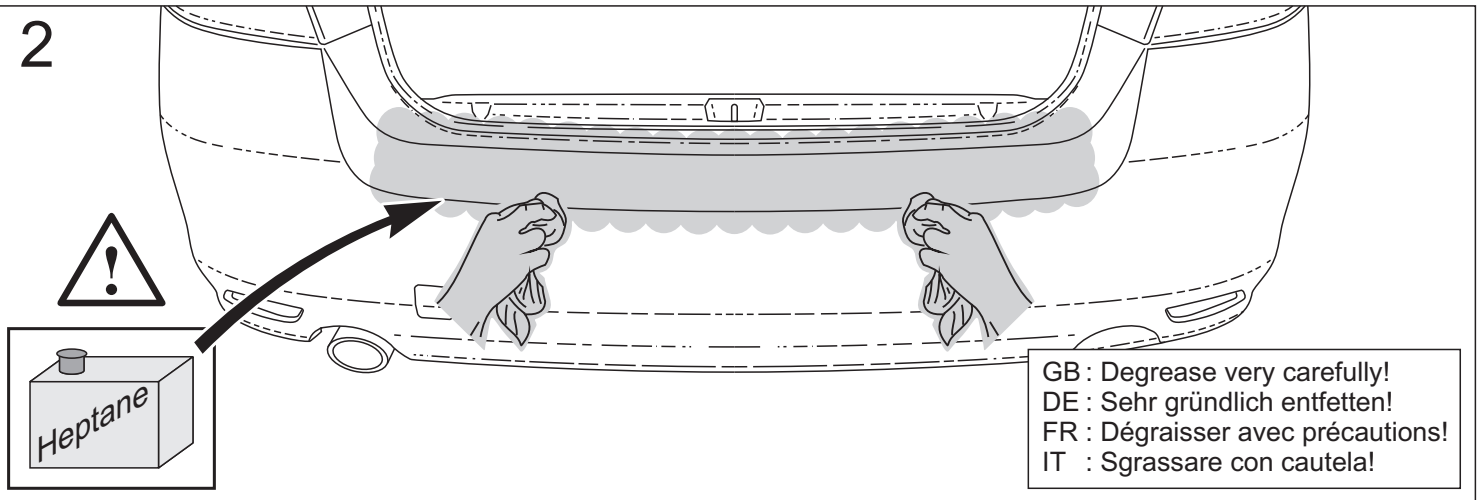

3

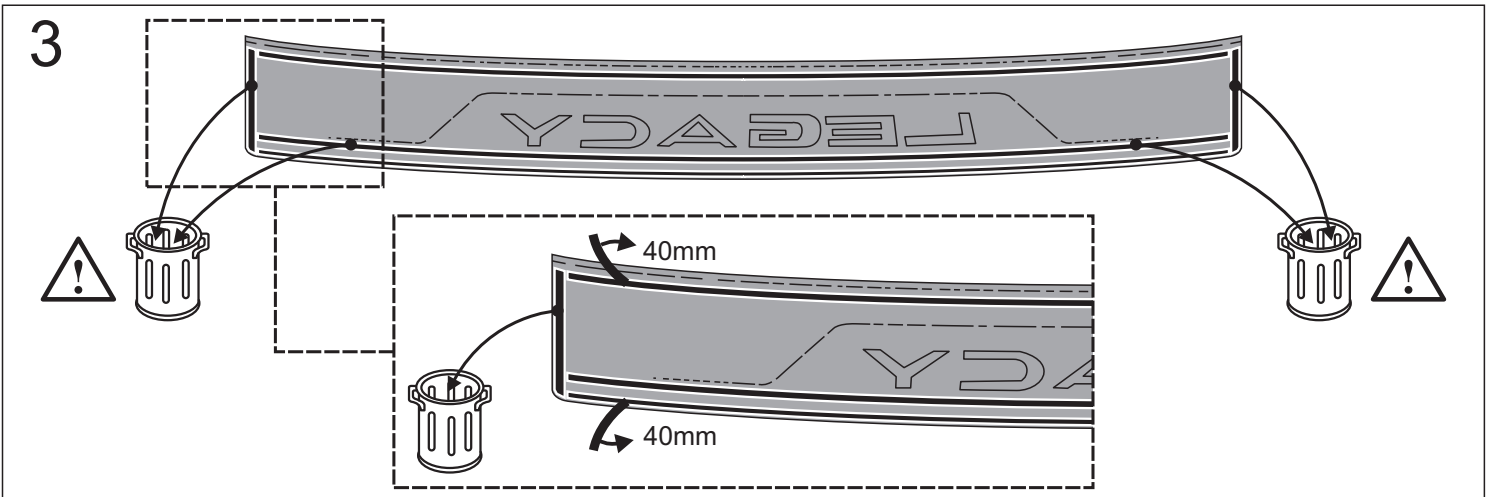

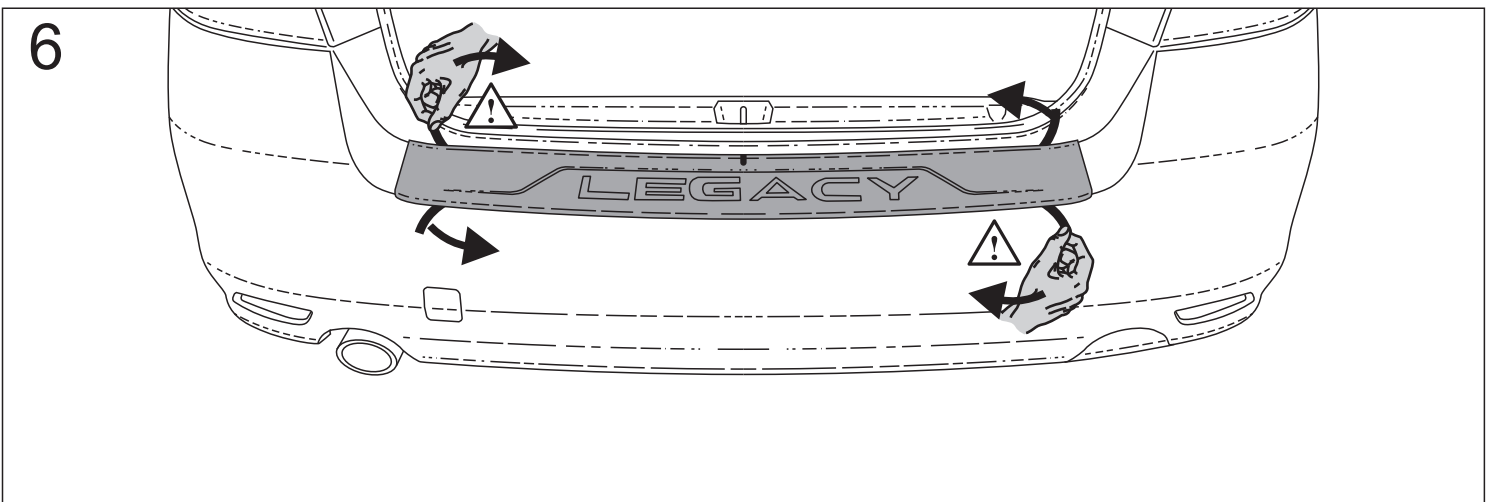
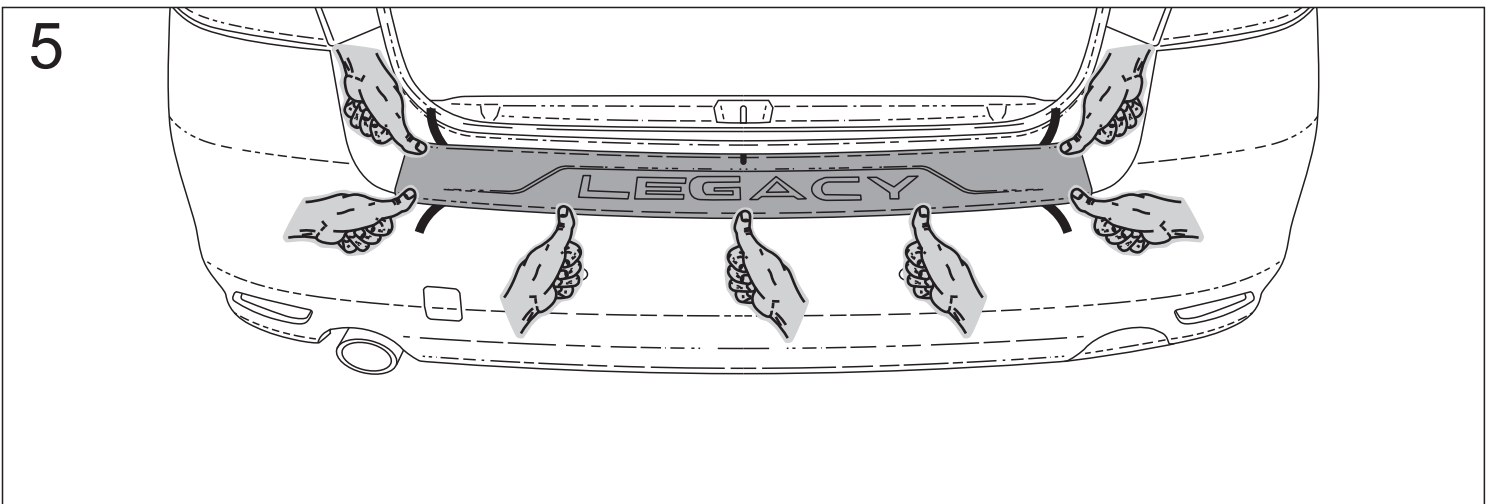
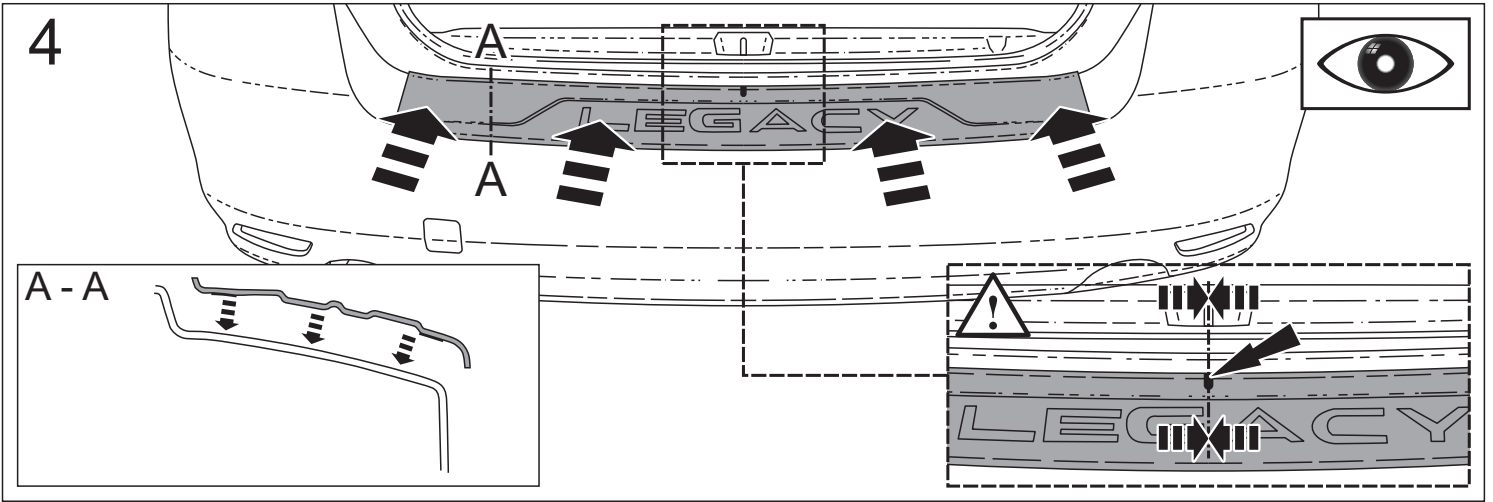

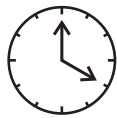
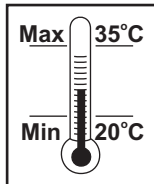
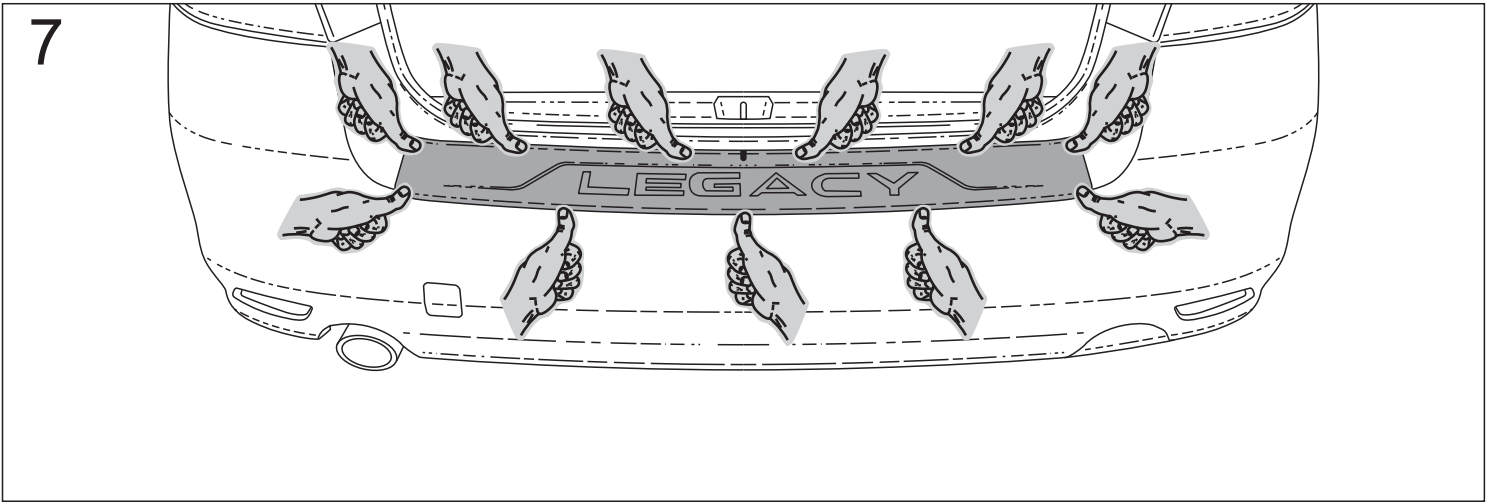

8Hrs

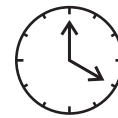
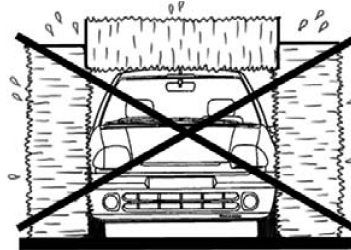

48Hrs

GB ATTENTION



Important notice! Guarantee/compensation claims will be automatically rejected if assembly has not been carried out correctly (in accordance with the instructions contained in this installation sheet) or in a specialist workshop.

We would expressly point out that any improper assembly/installation that has not been carried out in a specialist workshop will result in the invalidation of any kind of compensation claim, in particular, those arising by virtue of the product liability law.

The type no: E775EAJ010
is constructed for the above vehicle and can only be mounted on said vehicle. For the purpose of installation, please use the included fixation parts only.

FR ATTENTION



Nous attirons votre attention sur le fait toute réclamation ou demande de dommages et intérêts ne pourrait être formulée dans la mesure où le montage aura été effectué en suivant les instructions techniques prévues pour notre produit.

Le non-respect des instructions de montage entrainerait la non-recevabilité de toute réclamation.

Ce modèle E775EAJ010
est conçu pour le véhicule indiqué ci-dessus et ne peut être monté uniquement sur ce véhicule. Pour la fixation, utiliser exclusivement les pièces ci-jointes.

DE ACHTUNG



Wichtiger Hinweis! Gewährleistungs- bzw. Schadensersatzansprüche werden automatisch zurückgewiesen, falls die Montage unsachgemäß (d.h. nicht entsprechend den Anweisungen in dieser Montageanleitung) oder nicht in einer Fachwerkstatt durchgeführt wurde.

Wir weisen ausdrücklich darauf hin, daß eine unsachgemäße, nicht in einer Fachwerkstatt durchgeführte Montage, zum Ausschluß jeglicher Schadensersatzansprüche, insbesondere solcher aus dem Produkthaftpflichtgesetz, führt.

Der Typ Nr. E775EAJ010
ist für das oben aufgeführte Fahrzeug konstruiert und darf nur auf diesem Fahrzeug montiert werden. Für die Befestigung sind ausschließlich die beiliegenden Befestigungsteile zu verwenden.

IT ATTENZIONE



Attiriamo la vostra attenzione sul fatto che ogni eventuale reclamo o richiesta di risarcimento verra' da noi esaminata soltanto se l'installazione e' stata eseguita correttamente (in base alle istruzioni tecniche contenute nel nostro manuale) o presso uno dei nostri concessionari

A tal proposito vorremmo evidenziare che in caso di assemblaggio incorretto eseguito senza gli strumenti tecnici adeguati o non presso uno dei nostri concessionari non sara' possibile avvalersi di alcuna richiesta di risarcimento, in particolare non di quelle previste dalla legge della responsabilita' del prodotto.

Il tipo no : E775EAJ010
e' prodotto per il veicolo sopra menzionato e puo' essere montato soltanto sul suddetto veicolo. Per fissare tale prodotto si prega di utilizzare soltanto i pezzi allegati.