

GB	PEDAL SET Installation Instruction
D	PEDAL SET Einbauanleitung
E	JUEGO DE PEDALES Instrucciones de montaje
F	JEU DE PÉDALES Instructions de montage
I	SET PEDALI Istruzioni di montaggio
P	CONJUNTO DE PEDAIS Instruções de montagem
NL	PEDALSET Inbouw-instructie
DK	PEDALSÆT Monteringsvejledning
N	PEDALSATS Monteringsveiledning
S	PEDALSATS Monteringsanvisning
SF	POLKIMET Asennusohje
CZ	PEDÁLOVÁ SADA Návod k montáži
H	PEDÁLKÉSZLET Beszerelési utasítás
PL	ZESTAW DO PEDA OW Instrukcja zabudowy
GR	Σετ πεντάλ Οδηγίες τοποθέτησης
RUS	КОМПЛЕКТ ПЕДАЛИ ИНСТРУКЦИЯ ПО УСТАНОВКЕ



© Copyright MAZDA 2007

Expert Fitment Required

Montage durch Fachwerkstatt erforderlich

Montaje sólo por el concesionario

Montage par spécialiste nécessaire

E' necessario in officina specializzata

Especialista em montagem requerido

Montage door vakman nodig

Montage ved professionelt værksted påkrævet

Nødvendig med montering fra fagvegværksted

Værkstedsmontage erfordras

Asennus tarpeen merkkikorjaamossa

Montáž ve specializované dílně nutná

A szereléshez szakműhely kell

Konieczny montaż przez warsztat specjalistyczny

Na τοποθεί από συνεργείο

Необходима установка специалистами

Subject to alteration without notice

Technische Änderungen vorbehalten

Reservadas modificaciones técnicas

Sous réserve de modifications techniques

Con riserva di apportare modifiche tecniche

Reservamo-nos o direito a alterações técnicas

Technische wijzigingen voorbehouden

Med forbehold for tekniske ändringar

Tekniske forendringer forbeholdes

Med reservation för tekniska ändringar

Tekniset muutokset pidätetään

Technické zmeny vyhrazeny

A változtatások technika jogát fenntartjuk

Zmiany techniczne zastrzeżone

Επιφύλασσομεθα για αλλαγές

Можно изменять без уведомления

- 01 -

13/02/08



CC29-V8-220A
CC80-V8-220*
BN8B-V8-220*

- 01 -

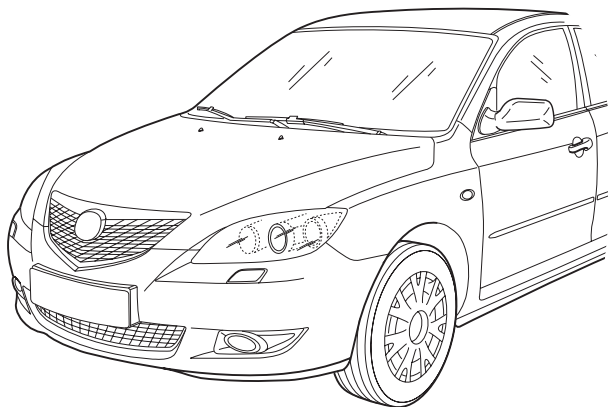

MAZDA 3 BK

JMZBK*****261962

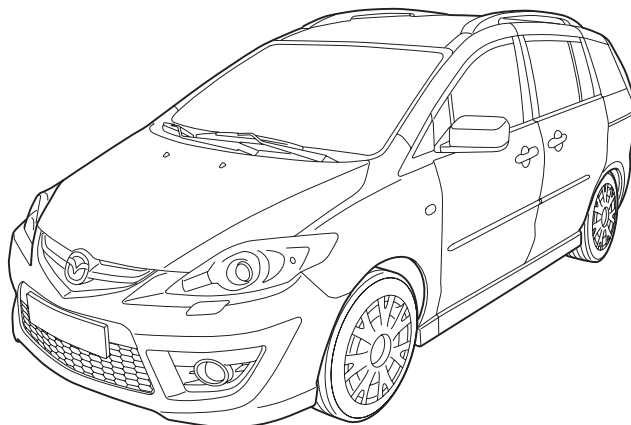

MAZDA 5 CR1

-02-

mazda

CC29-V8-220A
CC80-V8-220*
BN8B-V8-220*

-02-



- (GB)** Location/Position Arrow
- (D)** Positionspfeil
- (E)** Flecha de posición
- (F)** Flèche de Position
- (I)** Freccia di posizione
- (P)** Flexa de posição
- (NL)** Lokatie/Positie pijl
- (DK)** Lokaliseringspil
- (N)** Posisjonspil
- (S)** Positionpil
- (SF)** Paikannusnuoli
- (CZ)** Šipka na pozici
- (H)** Helyzetjelző nyíl
- (PL)** Strzałka położenia
- (GR)** Βέλος θέσης
- (RUS)** Позиция

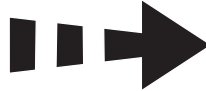







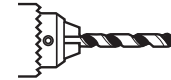



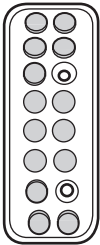
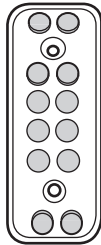
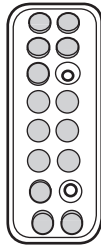

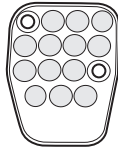
- (GB)** Movement Arrow
- (D)** Bewegungspfeil
- (E)** Flecha de movimiento
- (F)** Flèche indiquant sens du mouvement
- (I)** Freccia di movimento
- (P)** Flexa de movimento
- (NL)** Richtingspijl
- (DK)** Bevægelsespil
- (N)** Bevegelsespil
- (S)** Rörelsepil
- (SF)** Liikesuuntanuoli
- (CZ)** Šipka pohybu
- (H)** Mozgásirányjelző nyíl
- (PL)** Strzałka kierunku ruchu
- (GR)** Βέλος κίνησης
- (RUS)** Стрелка по направлению



- (GB)** Mark with Scriber
- (D)** Anreißen
- (E)** Rasgar
- (F)** Traces
- (I)** Tracciare
- (P)** Marcar con riscador
- (NL)** Aftekenen
- (DK)** Opmærkes
- (N)** Riss in
- (S)** Ritsa
- (SF)** Merkitse
- (CZ)** Natrhnout
- (H)** Tépje fel
- (PL)** Naznaczyć
- (GR)** Ακριβή Χάραξη
- (RUS)** Надорвите



- (GB)** Use Drill
- (D)** Bohrer verwenden
- (E)** Utilizar broca
- (F)** Utiliser une mèche
- (I)** Utilizzare trapano
- (P)** Utilizar a perfuradora
- (NL)** Boordiameter
- (DK)** Bor anvendes
- (N)** Bruk diameter
- (S)** Använd borr
- (SF)** Käytä poraa
- (CZ)** Použít vrták
- (H)** Használjon fúrót
- (PL)** Stosować wiertarkę
- (GR)** Χρησιμοποιείτε τρυπάνι
- (RUS)** Используйте дрель

A	CC29-V8-220A	CC80-V8-220*	BN8B-V8-220*
	 1x	 1x	 1x
B	 2x	 2x	 2x
C	 6x	 6x	 6x
D	 1x	E	 6x
F	G	E	G
 1x	 6x	 6x	 6x

CC29-V8-220A



1-7 / 14-17

Mazda 3
Mazda 5



8-10 / 14-17

Mazda 5 JMZCR *** 300.000



BN8B-V8-220*



8-10 / 14-17

Mazda 3 1,6 L

CC80-V8-220*



11-13 / 14-17

Mazda 3 2,0L
Mazda 5
Mazda 5 JMZCR *** 300.000



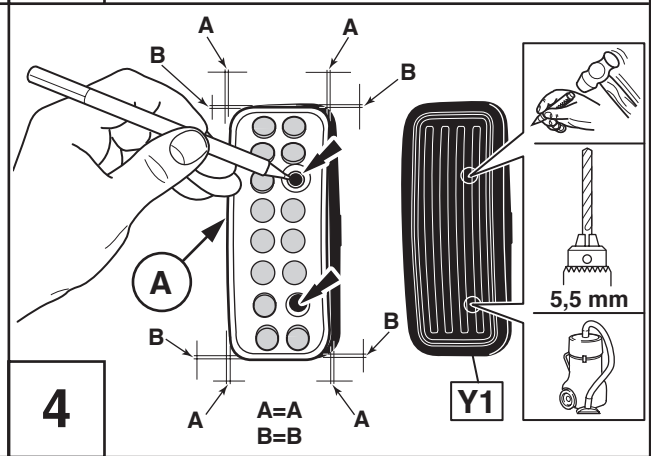
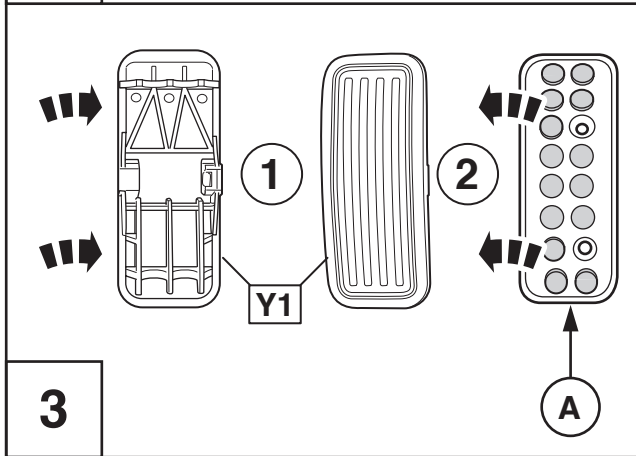
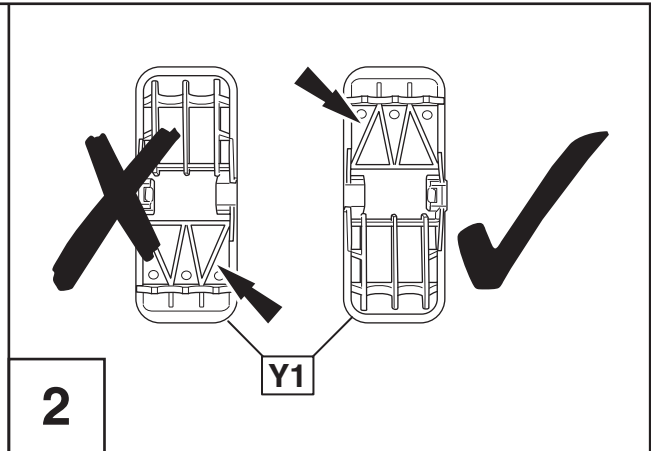
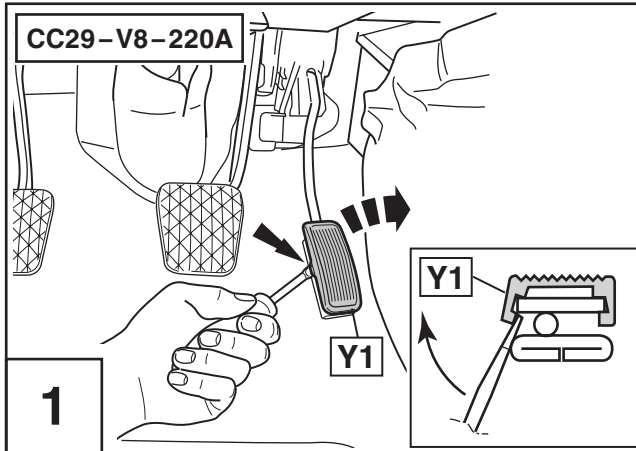

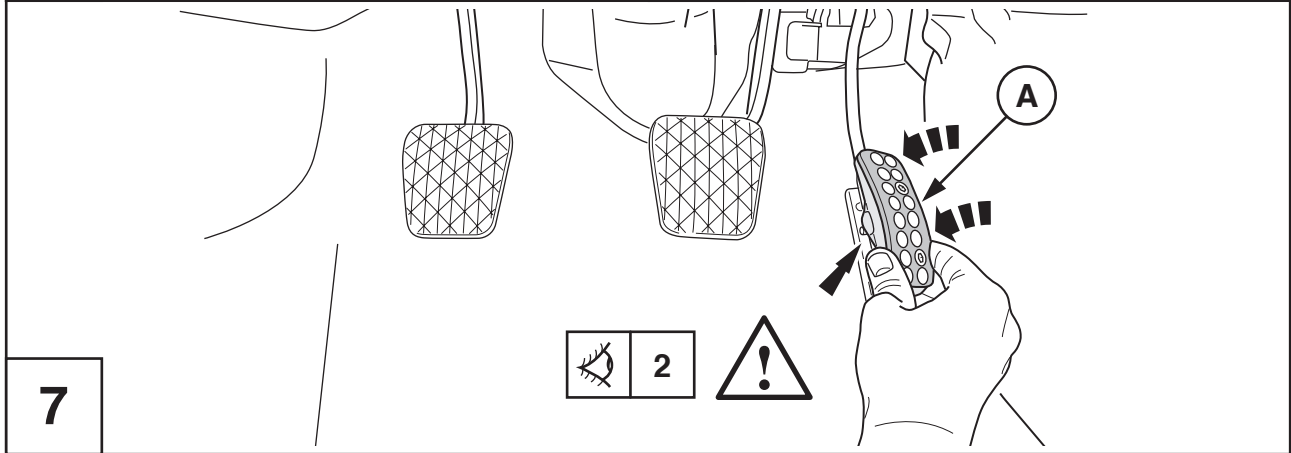
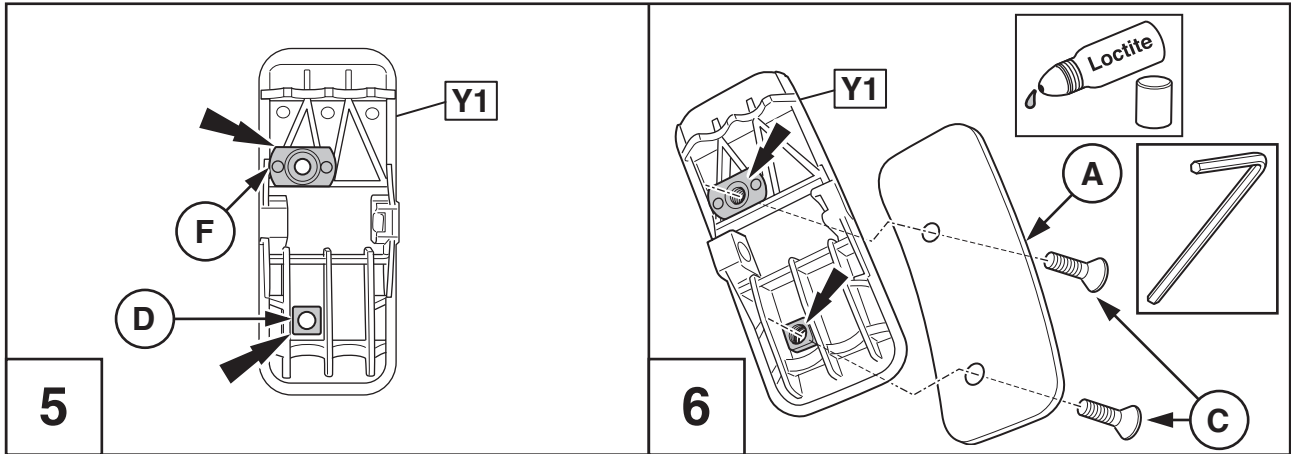

BN8B-V8-220*

CC29-V8-220A

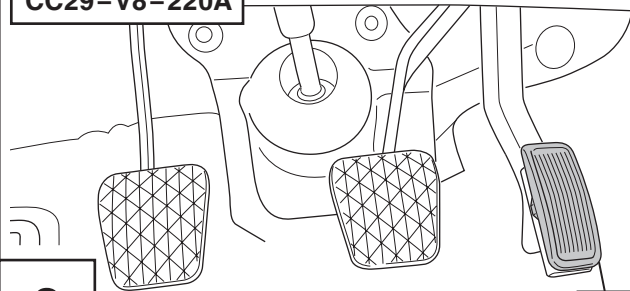

8

Y2

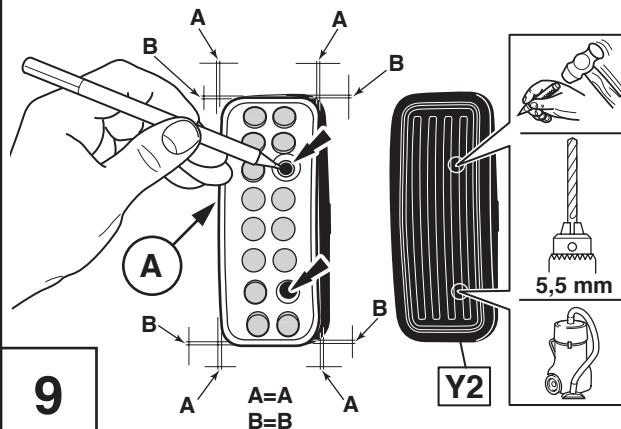

9

Y2

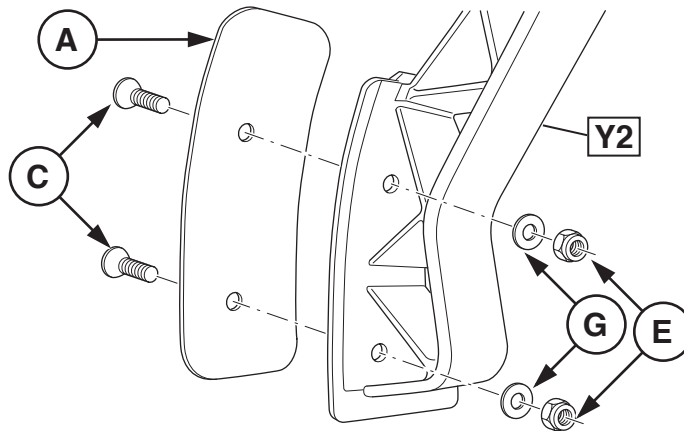

10

CC80-V8-220*

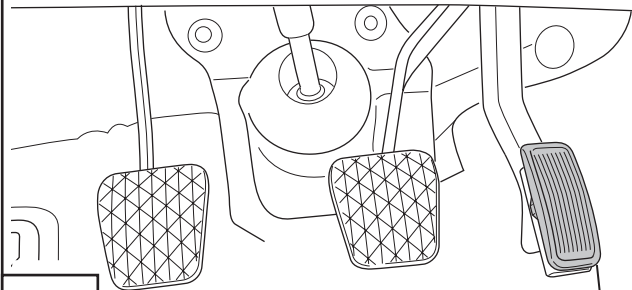

11

Y3

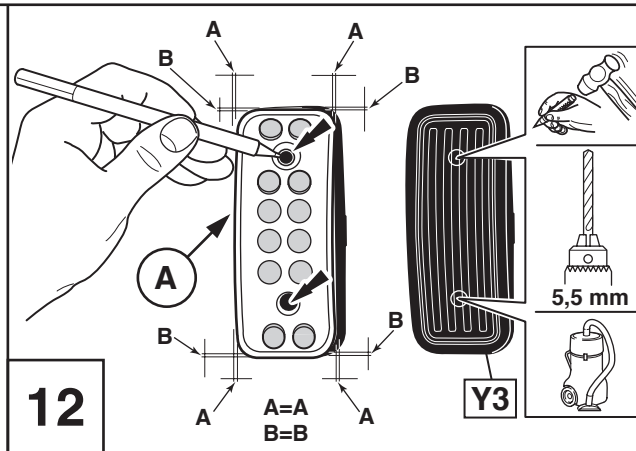

12

Y3

5,5 mm

A=A
B=B

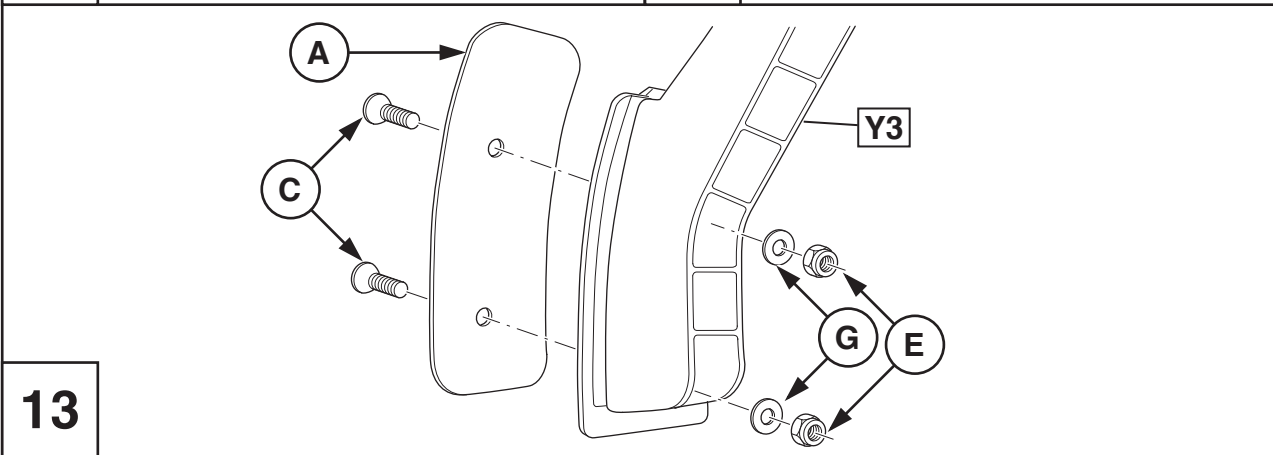

13

Y3

G

E

